

OutBack
POWER™
member of The  Group™

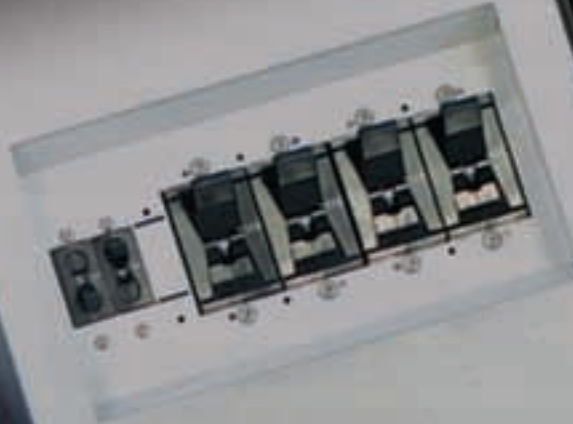

PRODUCT GUIDE



Welcome



OutBack Power Technologies is proud to continue designing and manufacturing solutions with you, the customer, in mind. OutBack maintains the philosophy that listening to our customers and innovating to meet their needs is paramount to our success.

This year we are pleased to introduce the FLEXpower line of fully pre-wired and factory tested single and dual inverter solutions. FLEXpower Systems are designed for a code compliant installation that saves you time and money. Single system part numbers and accessory kits for charge controllers and battery monitoring make ordering a complete OutBack Power system easier than ever!

OutBack is continuing to expand its industry-leading level of customer service adding to our team of qualified technical and order service personnel and we are excited to announce a newly added direct dial line for Technical Support, (360) 618-4363, expanded hours of operations (6am to 5pm PST) as well as online “live chat” support. We will continue to listen to, and learn from our customers, and continue to innovate.

We are confident that OutBack will continue to lead the way in bringing the solutions and services that people have come to depend on.

Thank you for your support as we continue *Powering the Planet*.

History

2001 OutBack was started by a passionate group of engineers who wanted to bring power conversion electronics technology into the 21st century.

This small startup quickly grew by offering innovative and well designed solutions to renewable energy problems. OutBack listened to their customers and made many of the changes that were suggested, creating a truly customer focused company in the power conversion electronics industry.

2002 OutBack introduces its first sealed sinewave inverter/charger, the FX2024 - with resounding success.

This single model changed the way people looked at system design by offering unprecedented flexibility in system design and expansion while the sealed construction allowed for uses which previously would have been considered too “extreme” for other inverter/chargers.

OutBack releases the MX60 solar MPPT Charge Controller which redefined performance and value, and quickly gained a reputation for getting the most power possible from a PV array - often making it more expensive to not use one.

2003 OutBack launches the first of the vented versions of the FX Series Inverter/Chargers.

These VFX models were introduced in direct response to our customers’ requests providing higher power at a similar price as the sealed counterpart.

OutBack launches the PS2, value priced system integration accessories.

This line of accessories addressed the needs of our customers for competitively priced system integration accessories for smaller systems.

2004 OutBack releases the world’s most efficient grid-interactive inverter/charger.

These models raise the bar for performance and value for battery-connected grid-interactive inverter/charger systems. OutBack introduces the PS1 fully integrated grid-interactive power system.

This unique system sets a new standard for system integration, performance and ease of installation in grid-interactive applications.

2005 OutBack reaches milestones in product deliveries and product recognition.

MX60 and FX Inverter production lines each ship 10,000th unit.

OutBack Power equipped teams sweep the top three places in the 2005 Solar Decathlon, an international competition between universities, to develop and build the most energy efficient home.

2006 OutBack Power launches FLEXware, a new line of balance of system components.

2007 OutBack Power expands product offerings to include the FLEXware Surge Protector, FLEXnet DC and FLEXmax 80.

OutBack Power Technologies doubles manufacturing capability.

2008 OutBack Power expands product offerings to include FLEXware PV.

2009 OutBack Power starts shipping the SmartRE Smart Renewable Energy System, a fully integrated grid-interactive solution.

2010 OutBack Power starts shipping FLEXpower pre-wired and factory tested systems.

2010 OutBack Power becomes a member of The Alpha Group.



- 4 FLEXpower ONE
- 6 SmartRE
- 8 Sinewave Inverter/Chargers
- 15 FLEXmax Charge Controllers
- 16 MATE
- 17 FLEXnet DC
- 18 HUB
- 19 Remote Temperature Sensor
- 20 FLEXware Surge Protector
- 22 Auto Transformer
- 23 FLEXware 250
- 25 FLEXware 500
- 28 FLEXware 1000
- 32 FLEXware MP
- 33 Components
- 36 FLEXware PV

Off-Grid

Solar. Wind. Hydro. Generator. No matter what your energy source OutBack's products are engineered to provide your home or business with reliable electricity day-in and day-out. The OutBack modular system architecture allows your system to grow along with your power needs up to 36,000 watts. Power-hungry appliances like washing machines, air conditioning and power tools are easily started by our inverter's substantial surge power capability. When not being used, the inverter enters a power save mode, which consumes as little as 3 watts, saving your battery power for when you need it the most. OutBack's innovative Maximum Power Point Tracking (MPPT) technology gets the most from your solar array or can also control hydro or wind turbine charging sources. Complete system status and control is easily monitored by a single control, instead of requiring the user to keep an eye on multiple displays and status indicators.



Grid-Interactive

Grid-Interactive renewable energy systems enable you to demonstrate your personal commitment to a renewable energy future. With the OutBack grid-interactive system, backup AC power is made available 24 hours a day in the event of a utility outage, providing reliable power, peace of mind and the ability to sell power back to the grid when excess power is available. Unlike traditional grid-tie systems OutBack's grid-interactive systems allow you to continue to utilize your renewable energy source in the event of a power outage. At night, the inverter's automatic power save mode ensures that energy is not wasted by needlessly charging your batteries from the utility grid. An average conversion efficiency of 91% using the California Energy Commission (CEC) test protocol provides greater savings and a shorter time period for system payback. OutBack's grid-interactive technology provides you more than a typical solar inverter, we also have an unmatched ability to utilize solar, wind and hydropower sources. OutBack grid-interactive inverters are designed to meet UL1741 specifications within the U.S. and Canada.



Mobile and Marine

OutBack's Mobile and Marine inverter/charger models provide the high performance and reliability you need no matter where your travels take you. Our die-cast metal construction allows mounting in any position, even upside down. The required AC input neutral/ground switching is taken care of by a fully integrated 30 amp AC transfer switch for shore cord or generator hook-up. Three circuit boards and a simple design make field servicing the unit easy no matter where you are. Rigorous testing at the factory ensures that each inverter/charger works the first time as well as for many years to come. OutBack mobile and marine inverters are designed to meet UL458.



The new FLEXpower ONE System accommodates all of the essential protective devices in the smallest possible space at the lowest installed cost making it ideal for applications with modest power requirements such as cabins, chalets, homes, remote communication sites and back-up power systems. Utilizing an extremely compact design and an easy-to-install mounting bracket, the fully pre-wired and factory-tested FLEXpower ONE System is designed for a quick installation, saving both time and money.

FLEXpower ONE includes a single inverter, AC and DC wiring boxes, a single FLEXmax Charge Controller, MATE, HUB, FLEXnet DC and Surge Protector while maintaining a small system footprint. The FLEXpower ONE System is also equipped with battery and PV array breakers, a PV GFDI breaker, an Input-Output-Bypass Assembly, mounting locations for both AC GFCI Type B and EU Type F style outlets and additional AC breakers. FLEXpower ONE components carry all of the necessary ETL certifications allowing for a code-compliant installation that saves both time and money while still looking great.

The OutBack Power FLEXpower ONE System is the only choice when you need a fully integrated, true-sinewave, reliable power system.



FLEXpower ONE Specifications

Prewired Systems*	Description	
FP1-1	FLEXpower ONE, Prewired AC and DC boxes with 120VAC Bypass and Type B Outlet, 250ADC breaker, GFDI, 80 amp charge controller breaker, VFX3524, MATE2, HUB4, RTS, FLEXmax 80, FLEXnet DC and surge protector for 120V 60Hz applications	
FP1-2	FLEXpower ONE, Prewired AC and DC boxes with 120VAC Bypass and Type B Outlet, 175ADC breaker, GFDI, 80 amp charge controller breaker, VFX3648, MATE2, HUB4, RTS, FLEXmax 80, FLEXnet DC and surge protector for 120V 60Hz applications	
FP1-3	FLEXpower ONE, Prewired AC and DC boxes with 120VAC Bypass and Type B Outlet, 250ADC breaker, GFDI, 80 amp charge controller breaker, GVFX3524, MATE2, HUB4, RTS, FLEXmax 80, FLEXnet DC and surge protector for 120V 60Hz applications	
FP1-4	FLEXpower ONE, Prewired AC and DC boxes with 120VAC Bypass and Type B Outlet, 175ADC breaker, GFDI, 80 amp charge controller breaker, GVFX3648, MATE2, HUB4, RTS, FLEXmax 80, FLEXnet DC and surge protector for 120V 60Hz applications	
FP1-5	FLEXpower ONE, Prewired AC and DC boxes with 230VAC Bypass and Type F Outlet, 250ADC breaker, GFDI, 80 amp charge controller breaker, VFX3024E, MATE2, HUB4, RTS, FLEXmax 80, FLEXnet DC and surge protector for 230V 50Hz applications	
FP1-6	FLEXpower ONE, Prewired AC and DC boxes with 230VAC Bypass and Type F Outlet, 175ADC breaker, GFDI, 80 amp charge controller breaker, VFX3048E, MATE2, HUB4, RTS, FLEXmax 80, FLEXnet DC and surge protector for 230V 50Hz applications	
Weight	Unit	98 lbs (44.5 kgs)
	Shipping	109 lbs (49.4 kgs)
Dimensions (H x W x L)	Unit	12.88 x 19.69 x 33.44" (32.72 x 50.01 x 84.94 cm)
	Shipping	17 x 22.75 x 38" (43.18 x 57.79 x 96.52 cm)

* Individual FLEXpower ONE components carry all necessary ETL certifications

* Specifications subject to change without notice

* Additional configurations available

Easily Mounts On To Bracket

The FLEXpower ONE system was designed with ease of installation in mind. The hanging bracket can be quickly installed allowing the entire system to be hung with minimal effort.



The new FLEXpower TWO System accommodates all of the essential protective devices in an easy-to-install, fully pre-wired and factory-tested dual-inverter system. The FLEXpower TWO is ideal for applications with medium-sized power requirements such as homes, light commercial or larger back-up power systems. Utilizing a compact design and an easy-to-install mounting plate, the FLEXpower TWO System can be mounted in either a horizontal or vertical orientation to allow installation in more space-limited locations and is designed for a quick installation, saving both time and money.



FLEXpower TWO includes two inverter/chargers, AC and DC wiring boxes, a MATE2, HUB, and Surge Protector* with optional kits for charge controllers and DC system monitoring, while maintaining a small system footprint. The FLEXpower TWO System is also equipped with battery breakers, an Input-Output-Bypass Assembly, mounting locations for GFCI Type B style AC outlets and locations for additional AC breakers. FLEXpower TWO components carry all of the necessary ETL certifications allowing for a code compliant installation that saves both time and money while still looking great.

The OutBack Power FLEXpower TWO System is the only choice when you need a fully integrated, true-sinewave, reliable power system.

* 120 VAC / 60 Hz Models

FLEXpower TWO Specifications

Pre-wired Systems*	Description	
FP2-10	7.2 kW FLEXpower TWO, Pre-wired AC and DC boxes with 120VAC Bypass, two 175ADC breakers, two VFX3648 inverter/chargers, MATE2, HUB10, RTS, X-240 and surge protector for 120V/240V 60Hz applications	
FP2-12	7 kW FLEXpower TWO, Pre-wired AC and DC boxes with 120VAC Bypass, two 250ADC breakers, two VFX3524 inverter/chargers, MATE2, HUB10, RTS, X-240 and surge protector for 120V/240V 60Hz applications	
FP2-22	6 kW FLEXpower TWO, Pre-wired AC and DC boxes with 230VAC Bypass, two 175ADC breakers, two VFX3048E inverter/chargers, MATE2, HUB10 and RTS for 230V 50Hz applications	
FP2-24	6 kW FLEXpower TWO, Pre-wired AC and DC boxes with 230VAC Bypass, two 250ADC breakers, two VFX3024E inverter/chargers, MATE2, HUB10 and RTS for 230V 50Hz applications	
FP2-28	7 kW FLEXpower TWO, Pre-wired AC and DC boxes with 120VAC Bypass, two 250ADC breakers, two GVFX3524 inverter/chargers, MATE2, HUB10, RTS, and surge protector for 120V/240V 60Hz applications	
FP2-29	7.2 kW FLEXpower TWO, Pre-wired AC and DC boxes with 120VAC Bypass, two 175ADC breakers, two GVFX3648 inverter/chargers, MATE2, HUB10, RTS, and surge protector for 120V/240V 60Hz applications	
FP2-31	6 kW FLEXpower TWO, Pre-wired AC and DC boxes with 120VAC Bypass, two 175ADC breakers, two FX3048T inverter/chargers, MATE2, HUB10, RTS, X-240 and surge protector for 120V/240V 60Hz applications	
FP2-32	5 kW FLEXpower TWO, Pre-wired AC and DC boxes with 120VAC Bypass, two 250ADC breakers, two FX2524T inverter/chargers, MATE2, HUB10, RTS, X-240 and surge protector for 120V/240V 60Hz applications	
Weight	Unit	232 lbs (105 kgs)
	Shipping	282 lbs (127 kgs)
Dimensions (H x W x D)	Unit	20.25 x 46.5 x 13 (51.4 x 118.1 x 33 cm)
	Shipping	21.5 x 47.5 x 20.5" (54.6 x 120.7 x 52.1 cm)

* Individual FLEXpower TWO components carry all necessary ETL certifications

* Specifications subject to change without notice

* Additional configurations available

SMARTRE™ Grid-Interactive Solution

SmartRE is the revolutionary Smart Renewable Energy solution from OutBack Power, bringing you simplified grid-tie solar with back-up power for residential and small commercial applications. Designed with an emphasis on ease of installation, a SmartRE solution installs and operates similarly to basic grid-tie solar inverters but with the unique additional benefit of providing UPS quality battery backup during utility outages. An integrated ultra-fast AC transfer switch guarantees that even sensitive backup loads, like computers, never know when a utility outage occurs. Recommended AGM batteries are maintained and charged by an innovative OutBack multi-stage charging process. This valuable feature assists in providing reliable backup power and will help extend your battery life up to 10 years.

The SmartRE is a versatile product and can be installed both indoors and outdoors. Available in power levels up to 3 kW and capable of providing as much as 34 kWh of back-up power during outages, there is a SmartRE solution for your application. With matching type 3R rainproof power electronics and battery enclosures constructed of aluminum, a SmartRE solution can be either wall or pad mounted, making this the most versatile grid-tie with battery backup solution on the market. This solution is designed and manufactured by OutBack Power to ensure that a SmartRE solution works reliably for years to come. A standard 5-year warranty, with an option to add an additional 5-year warranty, provides peace of mind.

Ease of installation, UPS quality battery backup, and solutions as large as 3kW along with proven OutBack engineering makes the SmartRE system the Smart choice for a premium Grid-Interactive solar power system.



SmartRE 2500/3000
with Battery Enclosure

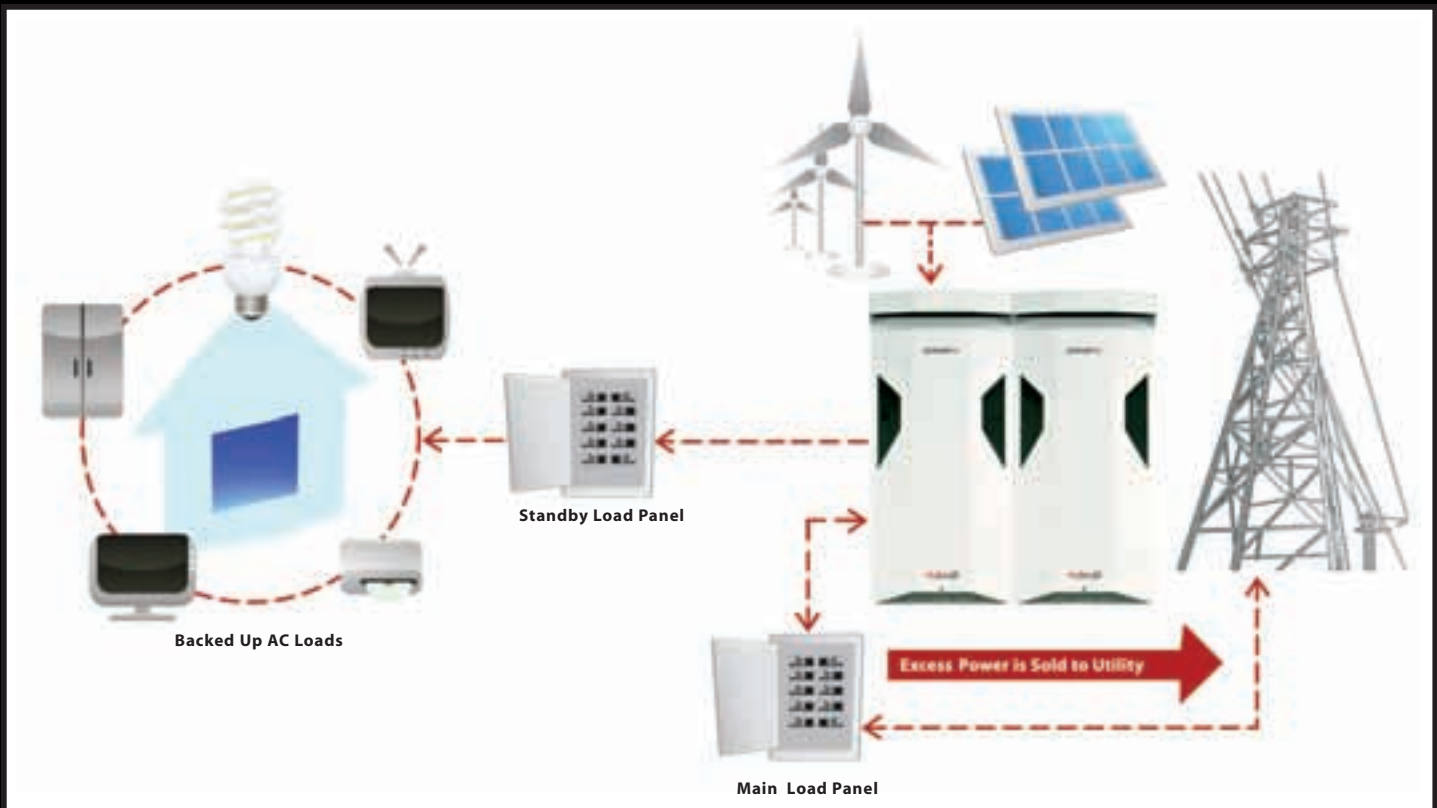

SMARTRE™ Specifications

Models		SMARTRE 2500		SMARTRE 3000	
Continuous Power Rating		2500VA		3000VA	
Part Numbers		SRE2500-120-NA	SRE2500-120/240-NA	SRE3000-120-NA	SRE3000-120/240-NA
Inverter Model		GTFX3048	GTFX3048	GVFX3648	GVFX3648
Charge Controller Model		FLEXmax 80	FLEXmax 80	FLEXmax 80	FLEXmax 80
AC SPECIFICATIONS					
Nominal AC Voltage	Sell	120VAC	120VAC	120VAC	120VAC
	Invert	120VAC	120VAC / 240VAC	120VAC	120VAC / 240VAC
Nominal Frequency Output		60 Hz	60 Hz	60 Hz	60 Hz
Maximum AC Current Output	Peak (1 millisecond)	70A at 120VAC	70A at 120VAC/35A at 240VAC	70A at 120VAC	70A at 120VAC/35A at 240VAC
	RMS (100 millisecond)	50A at 120VAC	50A at 120VAC/25A at 240VAC	50A at 120VAC	50A at 120VAC/25A at 240VAC
AC Overload Capability Output	Surge	6000VA		6000VA	
	5 Seconds	4800VA		5000VA	
	30 Minutes	3200VA		4000VA	
AC Output Current		20.8A at 120VAC	20.8A at 120VAC / 10.4A at 240VAC	25.0A at 120VAC	25.0 A at 120VAC / 12.5 A at 240VAC
Total Harmonic Distortion	Sell Current	<5%			
	Invert Voltage	2% Typical			
AC Inputs		Two 60A 120VAC AC Inputs [Grid / Generator]			
AC Transfer Switch Speed		<16 milliseconds			
Anti-Islanding Protection		UL1741-2005 / IEEE1547 Compliant			
Output Waveform		True Sine Wave			
DC SPECIFICATIONS					
Maximum PV Array Wattage - STC/Nameplate		4000 W DC STC	4000 W DC STC	4000 W DC STC	4000 W DC STC
MPPT PV Input Voltage Range		50-150 VDC VOC Including Maximum Voltage Temperature Correction			
MPPT PV Operating Voltage Range		50-145 VDC Including Maximum Voltage Temperature Correction			
Maximum PV Open Circuit Voltage		150VDC VOC			
Maximum PV Short Circuit Current		64A			
Ground Fault Protection		80A DC Breaker (Detection >0.5A)			
Electronic Overcurrent Protection		Yes			
Separate PV MPPT Inputs		1			
Maximum Battery Charger Output	AC Source (Grid or Gen.)	35A DC	35A DC	45A DC	45A DC
	DC Source (PV Array)	80A DC	80A DC	80A DC	80A DC
Battery Voltage	Nominal	48 VDC			
	Operating Range	42-68 VDC			
Recommended Minimum Battery Capacity		100 amp hours at 48VDC / ~ 4kWH			
Temperature Compensated Battery Charging		Yes			
SOLUTION SPECIFICATIONS					
Inverter Efficiency		Up to 93%			
Nighttime Consumption		0 W AC			
AC Input and Output Terminals		Accepts #2 to #14 AWG SET/Screw Type Compression Terminals			
Information Display		Battery State of Charge, PV Active, Inverter Output, Grid Active, Generator Active			
Integrated Communications		Included MATE 2 for Remote System Information			
Operating Temperature Range		-40° C to 60° C (power derated above 25° C)			
Batteries		Not Included			
Recommended Batteries		Group 27, Group 31 and Tall Group 31 AGM or Gel Cell Batteries (Please see documentation for list of compatible models)			
Enclosure Rating		Type 3R / Outdoor Rainproof			
Enclosure Materials		Aluminum			
Electronics Enclosure Mounting Options		Wall Mount (Bracket Included), Ground Mount, Concrete Pad Mount			
Enclosure Dimensions (HxWxD)		2 Enclosures: 42.75x19x20.38" (108.58x48.26x51.75 cm)			
Weight	Power Electronics	134lbs (60.7 kg)	166 lbs (75.3 kg)	134 lbs (60.7 kg)	166 lbs (75.3 kg)
	Battery Enclosures	44 lbs (19.9 kg) (not including batteries)			
Certifications		ETL Listed to UL1741, CSA C22.2 No. 107.1			
Warranty		5 Year Limited Warranty Standard/Optional 10 Year Warranty			
Options		Matching Battery Enclosure, Battery Enclosure Paralleling Kit, Battery Installation Kit			

• All specifications subject to change without notice.

Sinewave Inverter/Charger

OutBack inverterchargers are the next generation in advanced power management. Each is a DC to AC sinewave inverter, battery charger and AC transfer switch housed within a tough die-cast aluminum chassis.

Just like the local utility grid, the inverter produces true-sinewave AC electricity for your stand-alone or back-up power needs. Computers, TVs and pumps are just some of the examples of modern electronics that last longer and run better when powered with true sinewave electricity from an OutBack inverter. Starting up your air conditioning, washing machine or well pump is worry-free because of our high surge power capability.

Batteries and generators are the costly consumables when using inverters to generate electricity. The integrated smart battery charger uses multiple stages to perform quick recharging while prolonging battery life, saving your batteries and generator from unnecessary wear. Automatic switching between AC power sources is seamless due to an AC transfer switch that reacts in less than 16 milliseconds.

Unique networked communication is built into all OutBack products providing complete integration. Expanding your system with your growing power needs is as simple as adding additional inverters with our modular system architecture. Further flexibility is provided with the ability to be connected at any time in either parallel, series or three-phase power configurations. Industry-leading OutBack reliability is achieved through simplified design and rugged construction.

FX Sealed Inverter/Chargers

The FX series is designed to survive in environments that would normally destroy other inverterchargers. Protection for internal components is provided by our die-cast aluminum chassis with a powder coated finish to prevent corrosion. Internal and external cooling fins allow for heat transfer, enabling peak operating efficiencies as high as 93% and looking cool while doing it. Water and small particles are kept out through the generous use of gaskets and O-ring seals on all seams and openings. A protective conformal coating on all circuit boards provides the final line of defense against corrosion. The externally mounted "TURBO" cooling system improves performance in hot conditions.



VFX Vented Inverter/Chargers

The VFX series is designed for more protected installations. By utilizing an efficient active cooling design, the

VFX models are available with AC output up to 3.6 kilowatts. Our tough die-cast aluminum chassis physically protects the internal components while the air intake includes an easily cleaned filter, which allows for ventilation while also keeping bugs and other debris out. All circuit boards are conformal-coated to prevent corrosion from airborne moisture in humid conditions. The DC wiring cover (DCC) protects the DC terminals and battery cables from damage.



Off-Grid Specifications

	Sealed Models			Vented Models		
	FX2012T	FX2524T	FX3048T	VFX2812	VFX3524	VFX3648
Nominal DC Input Voltage	12 VDC	24 VDC	48 VDC	12 VDC	24 VDC	48 VDC
Continuous Power Rating at 25° C	2000 VA	2500 VA	3000 VA	2800 VA	3500 VA	3600 VA
AC Voltage/Frequency	120 VAC 60 Hz	120 VAC 60 Hz	120 VAC 60 Hz	120 VAC 60 Hz	120 VAC 60 Hz	120 VAC 60 Hz
Continuous AC RMS Output at 25° C	17.0 amps AC	20.8 amps AC	25.0 amps AC	23.3 amps AC	29.2 amps AC	30.0 amps AC
Idle Power	Full	≈ 20 Watts	≈ 20 Watts	≈ 20 Watts	≈ 20 Watts	≈ 23 Watts
	Search	≈ 6 Watts	≈ 6 Watts	≈ 6 Watts	≈ 6 Watts	≈ 6 Watts
Typical Efficiency	90%	92%	93%	90%	92%	93%
Total Harmonic Distortion	Typical	2%	2%	2%	2%	2%
	Maximum	5%	5%	5%	5%	5%
Output Voltage Regulation	± 2%	± 2%	± 2%	± 2%	± 2%	± 2%
Maximum Output Current	Peak	56 amps AC	70 amps AC	70 amps AC	56 amps AC	70 amps AC
	RMS	40 amps AC	50 amps AC	50 amps AC	40 amps AC	50 amps AC
AC Overload Capability	Surge	4800 VA	6000 VA	6000 VA	4800 VA	6000 VA
	5 Second	4000 VA	4800 VA	4800 VA	4000 VA	5000 VA
	30 Minutes	2500 VA	3200 VA	3200 VA	3200 VA	4000 VA
AC Input Current Maximum	60 amps AC	60 amps AC	60 amps AC	60 amps AC	60 amps AC	60 amps AC
AC Input Voltage Range (MATE Adjustable)	80 to 150 VAC	80 to 150 VAC	80 to 150 VAC	80 to 150 VAC	80 to 150 VAC	80 to 150 VAC
AC Input Frequency Range	54 to 66 Hz	54 to 66 Hz	54 to 66 Hz	54 to 66 Hz	54 to 66 Hz	54 to 66 Hz
DC Input Voltage Range	10.5 to 17.5 VDC	21.0 to 34.0 VDC	42.0 to 68.0 VDC	10.5 to 17.0 VDC	21.0 to 34.0 VDC	42.0 to 68.0 VDC
Continuous Battery Charge Output	80 amps DC	55 amps DC	35 amps DC	125 amps DC	85 amps DC	45 amps DC
Operating Temperature Range	-40° C to 60° C (power derated above 25° C)			-40° C to 60° C (power derated above 25° C)		
Warranty	Standard 2 year / Optional 5 year			Standard 2 year / Optional 5 year		
Weight	Unit	62 lbs (25 kg)			61 lbs (25 kg)	
	Shipping	67 lbs (30 kg)			64 lbs (28 kg)	
Dimensions (H x W x L)	Unit	13 x 8.25 x 16.25" (33 x 21 x 41 cm)			12 x 8.25 x 16.25" (30 x 21 x 41 cm)	
	Shipping	21.75 x 13 x 22" (55 x 33 x 56 cm)			21.75 x 13 x 22" (55 x 33 x 56 cm)	
Certifications	ETL Listed to UL1741 (for non-sellback only)			ETL Listed to UL1741 (for non-sellback only)		

Grid-Interactive Specifications

	Sealed Models		Vented Models	
	GTFX2524	GTFX3048	GVFX3524	GVFX3648
Nominal DC Input Voltage	24 VDC	48 VDC	24 VDC	48 VDC
Continuous Power Rating at 25° C	2500 VA	3000 VA	3500 VA	3600 VA
AC Voltage/Frequency	120 VAC 60 Hz	120 VAC 60 Hz	120 VAC 60 Hz	120 VAC 60 Hz
Continuous AC RMS Output at 25° C	20.8 amps AC	25.0 amps AC	29.2 amps AC	30.0 amps AC
Idle Power	Full	≈ 20 Watts	≈ 20 Watts	≈ 20 Watts
	Search	≈ 6 Watts	≈ 6 Watts	≈ 6 Watts
Typical Efficiency	92%	93%	92%	93%
Total Harmonic Distortion	Inverting	2%	2%	2%
	Selling	< 5%	< 5%	< 5%
Output Voltage Regulation	± 2%	± 2%	± 2%	± 2%
Maximum Output Current	Peak	70 amps AC	70 amps AC	70 amps AC
	RMS	50 amps AC	50 amps AC	50 amps AC
AC Overload Capability	Surge	6000 VA	6000 VA	6000 VA
	5 Second	4800 VA	4800 VA	5000 VA
	30 Minutes	3200 VA	3200 VA	4000 VA
AC Input Current Maximum	60 amps AC	60 amps AC	60 amps AC	60 amps AC
Sell back Voltage Range	108 to 132 VAC	108 to 132 VAC	108 to 132 VAC	108 to 132 VAC
AC Input Frequency Range	59.3 to 60.5 Hz	59.3 to 60.5 Hz	59.3 to 60.5 Hz	59.3 to 60.5 Hz
DC Input Range	21.0 to 34.0 VDC	42.0 to 68.0 VDC	21.0 to 34.0 VDC	42.0 to 68.0 VDC
Continuous Battery Charge Output	55 amps DC	35 amps DC	85 amps DC	45 amps DC
Operating Temperature Range	-40° C to 60° C (power derated above 25° C)		-40° C to 60° C (power derated above 25° C)	
Warranty	Standard 2 year / Optional 5 year		Standard 2 year / Optional 5 year	
Weight	Unit	62 lbs (25 kg)		61 lbs (25 kg)
	Shipping	67 lbs (30 kg)		64 lbs (28 kg)
Dimensions (H x W x L)	Unit	13 x 8.25 x 16.25" (33 x 21 x 41 cm)		12 x 8.25 x 16.25" (30 x 21 x 41 cm)
	Shipping	21.75 x 13 x 22" (55 x 33 x 56 cm)		21.75 x 13 x 22" (55 x 33 x 56 cm)
Certifications	ETL Listed to UL1741, CSA C22.2 No. 107.1	ETL Listed to UL1741, CSA C22.2 No. 107.1 Listed on CEC eligible equipment list	ETL Listed to UL1741, CSA C22.2 No. 107.1	ETL Listed to UL1741, CSA C22.2 No. 107.1 Listed on CEC eligible equipment list

• These products were designed to meet UL1741 specifications within the U.S. and Canada. Please check your local nominal power voltage ratings in areas where grid specifications might fluctuate.

• Specifications subject to change without notice.

50 Hz Off-Grid Specifications

	Sealed Models			Vented Models		
	FX2012ET	FX2024ET	FX2348ET	VFX2612E	VFX3024E	VFX3048E
Nominal DC Input Voltage	12 VDC	24 VDC	48 VDC	12 VDC	24 VDC	48 VDC
Continuous Power Rating at 25° C	2000 VA	2000 VA	2300 VA	2600 VA	3000 VA	3000 VA
AC Voltage/Frequency	230 VAC 50 Hz	230 VAC 50 Hz	230 VAC 50 Hz	230 VAC 50 Hz	230 VAC 50 Hz	230 VAC 50 Hz
Continuous AC RMS Output at 25° C	8.7 amps AC	8.7 amps AC	10.0 amps AC	11.3 amps AC	13.0 amps AC	13.0 amps AC
Idle Power	Full	≈ 20 Watts	≈ 20 Watts	≈ 20 Watts	≈ 20 Watts	≈ 23 Watts
	Search	≈ 6 Watts	≈ 6 Watts	≈ 6 Watts	≈ 6 Watts	≈ 6 Watts
Typical Efficiency	90%	92%	93%	90%	92%	93%
Total Harmonic Distortion	Typical	2%	2%	2%	2%	2%
	Maximum	5%	5%	5%	5%	5%
Output Voltage Regulation	± 2%	± 2%	± 2%	± 2%	± 2%	± 2%
Maximum Output Current	Peak	28 amps AC	35 amps AC	35 amps AC	28 amps AC	35 amps AC
	RMS	20 amps AC	25 amps AC	25 amps AC	20 amps AC	25 amps AC
AC Overload Capability	Surge	4600 VA	5750 VA	5750 VA	4600 VA	5750 VA
	5 Second	4000 VA	4800 VA	4800 VA	4000 VA	4800 VA
	30 Minutes	2500 VA	3100 VA	3100 VA	3100 VA	3300 VA
AC Input Current Maximum	30 amps AC	30 amps AC	30 amps AC	30 amps AC	30 amps AC	30 amps AC
AC Input Voltage Range (MATE Adjustable)	160 to 300 VAC	160 to 300 VAC	160 to 300 VAC	160 to 300 VAC	160 to 300 VAC	160 to 300 VAC
AC Input Frequency Range	44 to 56 Hz	44 to 56 Hz	44 to 56 Hz	44 to 56 Hz	44 to 56 Hz	44 to 56 Hz
DC Input Voltage Range	10.5 to 17.0 VDC	21.0 to 34.0 VDC	42.0 to 68.0 VDC	10.5 to 17.0 VDC	21.0 to 34.0 VDC	42.0 to 68.0 VDC
Continuous Battery Charge Output	100 amps DC	55 amps DC	35 amps DC	120 amps DC	85 amps DC	45 amps DC
Operating Temperature Range	-40° C to 60° C (power derated above 25° C)			-40° C to 60° C (power derated above 25° C)		
Warranty	Standard 2 year / Optional 5 year			Standard 2 year / Optional 5 year		
Weight	Unit	62 lbs (25 kg)			61 lbs (25 kg)	
	Shipping	67 lbs (30 kg)			64 lbs (28 kg)	
Dimensions (H x W x L)	Unit	13 x 8.25 x 16.25" (33 x 21 x 41 cm)			12 x 8.25 x 16.25" (30 x 21 x 41 cm)	
	Shipping	21.75 x 13 x 22" (55 x 33 x 56 cm)			21.75 x 13 x 22" (55 x 33 x 56 cm)	

50 Hz Grid-Interactive Specifications

	GTFX2024ET	GTFX2348ET	GVPX3024E	GVPX3048E
Nominal DC Input Voltage	24 VDC	48 VDC	24 VDC	48 VDC
Continuous Power Rating at 25° C	2000 VA	2300 VA	3000 VA	3000 VA
AC Voltage/Frequency	230 VAC 50 Hz	230 VAC 50 Hz	230 VAC 50 Hz	230 VAC 50 Hz
Continuous AC RMS Output at 25° C	8.7 amps AC	10.0 amps AC	13.0 amps AC	13.0 amps AC
Idle Power	Full	≈ 20 Watts	≈ 23 Watts	≈ 20 Watts
	Search	≈ 6 Watts	≈ 6 Watts	≈ 6 Watts
Typical Efficiency	92%	92%	92%	93%
Total Harmonic Distortion	Inverting	2%	2%	2%
	Selling	< 5%	< 5%	< 5%
Output Voltage Regulation	± 2%	± 2%	± 2%	± 2%
Maximum Output Current	Peak	35 amps AC	35 amps AC	35 amps AC
	RMS	25 amps AC	25 amps AC	25 amps AC
AC Overload Capability	Surge	5750 VA	5750 VA	5750 VA
	5 Second	4800 VA	4800 VA	4800 VA
	30 Minutes	3100 VA	3100 VA	3300 VA
AC Input Current Maximum	30 amps AC	30 amps AC	30 amps AC	30 amps AC
Sell back Voltage Range	140 to 280 VAC	140 to 280 VAC	140 to 280 VAC	140 to 280 VAC
AC Input Frequency Range	45 to 55 Hz	45 to 55 Hz	45 to 55 Hz	45 to 55 Hz
DC Input Range	21.0 to 34.0 VDC	42.0 to 68.0 VDC	21.0 to 34.0 VDC	42.0 to 68.0 VDC
Continuous Battery Charge Output	50 amps DC	30 amps DC	80 amps DC	40 amps DC
Operating Temperature Range	-40° C to 60° C (power derated above 25° C)		-40° C to 60° C (power derated above 25° C)	
Warranty	Standard 2 year / Optional 5 year		Standard 2 year / Optional 5 year	
Weight	Unit	62 lbs (25 kg)		61 lbs (25 kg)
	Shipping	67 lbs (30 kg)		64 lbs (28 kg)
Dimensions (H x W x L)	Unit	13 x 8.25 x 16.25" (33 x 21 x 41 cm)		12 x 8.25 x 16.25" (30 x 21 x 41 cm)
	Shipping	21.75 x 13 x 22" (55 x 33 x 56 cm)		21.75 x 13 x 22" (55 x 33 x 56 cm)

• Specifications subject to change without notice.

Mobile Specifications

		<i>Sealed Models</i>			
		FX2012MT	FX2524MT	FX2532MT	FX2536MT
Nominal DC Input Voltage		12 VDC	24 VDC	32 VDC	36 VDC
Continuous Power Rating at 25° C		2000 VA	2500 VA	2500 VA	2500 VA
AC Voltage/Frequency		120 VAC 60 Hz	120 VAC 60 Hz	120 VAC 60 Hz	120 VAC 60 Hz
Continuous AC RMS Output at 25° C		17.0 amps AC	20.8 amps AC	20.8 amps AC	20.8 amps AC
Idle Power	Full	20 Watts	20 Watts	21 Watts	21 Watts
	Search	6 Watts	6 Watts	6 Watts	6 Watts
Typical Efficiency		90%	92%	92%	92%
Total Harmonic Distortion	Typical	2%	2%	2%	2%
	Maximum	5%	5%	5%	5%
Output Voltage Regulation		± 2%	± 2%	± 2%	± 2%
Maximum Output Current	Peak	56 amps AC	70 amps AC	56 amps AC	56 amps AC
	RMS	40 amps AC	50 amps AC	40 amps AC	40 amps AC
AC Overload Capability	Surge	4800 VA	6000 VA	4800 VA	4800 VA
	5 Second	4000 VA	4800 VA	4000 VA	4000 VA
	30 Minutes	2500 VA	3200 VA	2500 VA	2500 VA
AC Input Current Maximum		30 amps AC	30 amps AC	30 amps AC	30 amps AC
AC Input Voltage Range (Adjustable)		80 to 150 VAC	80 to 150 VAC	80 to 150 VAC	80 to 150 VAC
AC Input Frequency Range		54 to 66 Hz	54 to 66 Hz	54 to 66 Hz	54 to 66 Hz
DC Input Range		10.5 to 17.0 VDC	21.0 to 34.0 VDC	28.0 to 45.3 VDC	31.5 to 51.0 VDC
Continuous Battery Charge Output		80 amps DC	55 amps DC	35 amps DC	35 amps DC
Operating Temperature Range		-40° C to 60° C (power derated above 25° C)		-40° C to 60° C (power derated above 25° C)	
Warranty		Standard 2 year / Optional 5 year		Standard 2 year / Optional 5 year	
Weight	Unit	62 lbs (25 kg)		62 lbs (25 kg)	
	Shipping	67 lbs (30 kg)		67 lbs (30 kg)	
Dimensions (H x W x L)	Unit	13 x 8.25 x 16.25" (33 x 21 x 41 cm)		13 x 8.25 x 16.25" (33 x 21 x 41 cm)	
	Shipping	21.75 x 13 x 22" (55 x 33 x 56 cm)		21.75 x 13 x 22" (55 x 33 x 56 cm)	
Certifications		ETL Listed to UL458		ETL Listed to UL458	

Mobile Specifications

		<i>Vented Models</i>			
		VFX2812M	VFX3524M	VFX3232M	VFX3236M
Nominal DC Input Voltage		12 VDC	24 VDC	32 VDC	36 VDC
Continuous Power Rating at 25° C		2800 VA	3500 VA	3200 VA	3200 VA
AC Voltage/Frequency		120 VAC 60 Hz	120 VAC 60 Hz	120 VAC 60 Hz	120 VAC 60 Hz
Continuous AC RMS Output at 25° C		23.3 amps AC	29.2 amps AC	26.6 amps AC	26.6 amps AC
Idle Power	Full	20 Watts	20 Watts	21 Watts	21 Watts
	Search	6 Watts	6 Watts	6 Watts	6 Watts
Typical Efficiency		90%	92%	92%	92%
Total Harmonic Distortion	Typical	2%	2%	2%	2%
	Maximum	5%	5%	5%	5%
Output Voltage Regulation		± 2%	± 2%	± 2%	± 2%
Maximum Output Current	Peak	56 amps AC	70 amps AC	56 amps AC	56 amps AC
	RMS	40 amps AC	50 amps AC	40 amps AC	40 amps AC
AC Overload Capability	Surge	4800 VA	6000 VA	4800 VA	4800 VA
	5 Second	4000 VA	5000 VA	4000 VA	4000 VA
	30 Minutes	3200 VA	4000 VA	2000 VA	4000 VA
AC Input Current Maximum		30 amps AC	30 amps AC	30 amps AC	30 amps AC
AC Input Voltage Range (Adjustable)		80 to 150 VAC	80 to 150 VAC	80 to 150 VAC	80 to 150 VAC
AC Input Frequency Range		54 to 66 Hz	54 to 66 Hz	54 to 66 Hz	54 to 66 Hz
DC Input Range		10.5 to 17.0 VDC	21.0 to 34.0 VDC	28.0 to 45.3 VDC	31.5 to 51.0 VDC
Continuous Battery Charge Output		125 amps DC	85 amps DC	45 amps DC	45 amps DC
Operating Temperature Range		-40° C to 60° C (power derated above 25° C)		-40° C to 60° C (power derated above 25° C)	
Warranty		Standard 2 year / Optional 5 year		Standard 2 year / Optional 5 year	
Weight	Unit	61 lbs (25 kg)		61 lbs (25 kg)	
	Shipping	64 lbs (28 kg)		64 lbs (28 kg)	
Dimensions (H x W x L)	Unit	12 x 8.25 x 16.25" (30 x 21 x 41 cm)		12 x 8.25 x 16.25" (30 x 21 x 41 cm)	
	Shipping	21.75 x 13 x 22" (55 x 33 x 56 cm)		21.75 x 13 x 22" (55 x 33 x 56 cm)	
Certifications		ETL Listed to UL458		ETL Listed to UL458	

• Specifications subject to change without notice.

Additional Off-Grid Inverter Specifications

		FX2024JT	FX2024WT	FX2348WT	VFX3024J	VFX3024W	VFX3048W
Nominal DC Input Voltage		24 VDC	24 VDC	48 VDC	24 VDC	24 VDC	48 VDC
Continuous Power Rating at 25° C		2000 VA	2000 VA	2300 VA	3000 VA	3000 VA	3000 VA
AC Voltage/Frequency		120 VAC 50 Hz	230 VAC 60 Hz	230 VAC 60 Hz	120 VAC 50 Hz	230 VAC 60 Hz	230 VAC 60 Hz
Continuous AC RMS Output at 25° C		16.7 amps AC	8.7 amps AC	10 amps AC	25 amps AC	13 amps AC	13 amps AC
Idle Power	Full	≈ 20 Watts	≈ 20 Watts	≈ 23 Watts	≈ 20 Watts	≈ 20 Watts	≈ 23 Watts
	Search	≈ 6 Watts	≈ 6 Watts	≈ 6 Watts	≈ 6 Watts	≈ 6 Watts	≈ 6 Watts
Typical Efficiency		92%	92%	93%	92%	92%	93%
Total Harmonic Distortion	Typical	2%	2%	2%	2%	2%	2%
	Maximum	5%	5%	5%	5%	5%	5%
Output Voltage Regulation		+/- 2%	+/- 2%	+/- 2%	+/- 2%	+/- 2%	+/- 2%
Maximum Output Current	Peak	70 amps AC	35 amps AC	35 amps AC	70 amps AC	35 amps AC	35 amps AC
	RMS	50 amps AC	50 amps AC	25 amps AC	50 amps AC	25 amps AC	25 amps AC
AC Overload Capability	Surge	5750 VA	5750 VA	5750 VA	5750 VA	5750 VA	5750 VA
	5 Second	4800 VA	4800 VA	4800 VA	4800 VA	4800 VA	4800 VA
	30 Minutes	3100 VA	3100 VA	3100 VA	3100 VA	3100 VA	3100 VA
AC Input Current Maximum		60 amps AC	30 amps AC	30 amps AC	60 amps AC	30 amps AC	30 amps AC
AC Input Voltage Range (MATE Adjustable)		80 to 150 VAC	160 to 300 VAC	160 to 300 VAC	80 to 150 VAC	160 to 300 VAC	160 to 300 VAC
AC Input Frequency Range		44 to 56 Hz	54 to 66 Hz	54 to 66 Hz	44 to 56 Hz	54 to 66 Hz	54 to 66 Hz
DC Input Voltage Range		21.0 to 34.0 VDC	21.0 to 34.0 VDC	42.0 to 68.0 VDC	21.0 to 34.0 VDC	21.0 to 34.0 VDC	42.0 to 68.0 VDC
Continuous Battery Charge Output		55 amps DC	55 amps DC	35 amps DC	85 amps DC	85 amps DC	45 amps DC
Operating Temperature Range		-40° C to 60° C (power derated above 25° C)			-40° C to 60° C (power derated above 25° C)		
Warranty		Standard 2 year / Optional 5 year			Standard 2 year / Optional 5 year		
Weight	Unit	62 lbs (25 kg)			61 lbs (25 kg)		
	Shipping	67 lbs (30 kg)			67 lbs (30 kg)		
Dimensions (H x W x L)	Unit	13 x 8.25 x 16.25" (33 x 21 x 41 cm)			12 x 8.25 x 16.25" (30 x 21 x 41 cm)		
	Shipping	21.75 x 13 x 22" (55 x 33 x 56 cm)			21.75 x 13 x 22" (55 x 33 x 56 cm)		

Additional Grid-Interactive Model Specifications

		GTFX2524LA	GTFX3048LA	GVFX3524LA	GVFX3648LA
Nominal DC Input Voltage		24 VDC	48 VDC	24 VDC	48 VDC
Continuous Power Rating at 25° C		2500 VA	3000 VA	3500 VA	3600 VA
AC Voltage/Frequency		127 VAC 60 Hz	127 VAC 60 Hz	127 VAC 60 Hz	127 VAC 60 Hz
Continuous AC RMS Output at 25° C		19.7 amps AC	23.6 amps AC	27.6 amps AC	28.4 amps AC
Idle Power	Full	≈ 20 Watts	≈ 20 Watts	≈ 20 Watts	≈ 23 Watts
	Search	≈ 6 Watts	≈ 6 Watts	≈ 6 Watts	≈ 6 Watts
Typical Efficiency		92%	93%	92%	93%
Total Harmonic Distortion	Typical	2%	2%	2%	2%
	Maximum	5%	5%	5%	5%
Output Voltage Regulation		+/- 2%	+/- 2%	+/- 2%	+/- 2%
Maximum Output Current	Peak	70 amps AC	70 amps AC	70 amps AC	70 amps AC
	RMS	50 amps AC	50 amps AC	50 amps AC	50 amps AC
AC Overload Capability	Surge	6000 VA	6000 VA	6000 VA	6000 VA
	5 Second	4800 VA	4800 VA	5000 VA	5000 VA
	30 Minutes	3200 VA	3200 VA	4000 VA	4000 VA
AC Input Current Maximum		60 amps AC	60 amps AC	60 amps AC	60 amps AC
AC Input Voltage Range (MATE Adjustable)		100 to 140 VAC	100 to 140 VAC	100 to 140 VAC	100 to 140 VAC
AC Input Frequency Range		58 to 62 Hz	58 to 62 Hz	58 to 62 Hz	58 to 62 Hz
DC Input Voltage Range		21.0 to 34.0 VDC	42.0 to 68.0 VDC	21.0 to 34.0 VDC	42.0 to 68.0 VDC
Continuous Battery Charge Output		55 amps DC	35 amps DC	85 amps DC	45 amps DC
Operating Temperature Range		-40° C to 60° C (power derated above 25° C)		-40° C to 60° C (power derated above 25° C)	
Warranty		Standard 2 year / Optional 5 year		Standard 2 year / Optional 5 year	
Weight	Unit	62 lbs (25 kg)		61 lbs (25 kg)	
	Shipping	67 lbs (30 kg)		67 lbs (30 kg)	
Dimensions (H x W x L)	Unit	13 x 8.25 x 16.25" (33 x 21 x 41 cm)		12 x 8.25 x 16.25" (30 x 21 x 41 cm)	
	Shipping	21.75 x 13 x 22" (55 x 33 x 56 cm)		21.75 x 13 x 22" (55 x 33 x 56 cm)	

*** NOTE: THIS PRODUCT IS NOT ETL LISTED TO UL1741. NOT INTENDED FOR USE IN THE U.S. OR CANADA.***

GFX International Series Inverter/Charger

The OutBack true sinewave GFX International Series Inverter/Charger is a competitive power solution designed for applications with lower power demands. Incorporating a DC-to-AC sinewave inverter, battery charger and AC transfer relay housed within a die-cast aluminum chassis, the International Series GFX Inverter/Chargers give you the ability to sell solar, wind or hydro power back to the utility grid while providing instantaneous back-up power in the event of a utility outage.

The GFX International Series is designed for use in countries that have utility grids with nominal AC voltages of 230 VAC / 50Hz. Our built in transfer relay automatically disconnects your loads from the utility grid and powers them from the inverter in the event of an outage, allowing you to continue using your solar and battery back-up power, unlike traditional grid-tie systems. For areas that frequently experience power instability such as surges, spikes or brownouts, or where standard inverters have trouble syncing to the utility grid, the GFX International Series grid reconnect timers have been shortened to reduce overall sell-back downtime and improve system functionality.

Intelligent multi-stage battery charging prolongs the life of your batteries and built-in networked communications allow for simultaneous communications of up to ten OutBack Power components within the system. The exclusive modular system architecture means that increased power output is just an additional inverter/charger away. Our GFX International Series uses a sealed chassis that can operate in the harshest environmental conditions such as high humidity and corrosive salt air.



GFX International Series

Sealed Models

		GFX1312E	GFX1424E	GFX1448E
Nominal DC Input Voltage		12 VDC	24 VDC	48 VDC
Continuous Power Rating at 25° C		1300 VA	1400 VA	1400 VA
AC Voltage/Frequency		230 VAC 50 Hz	230 VAC 50 Hz	230 VAC 50 Hz
Continuous AC RMS Output at 25° C		5.65 amps AC	6.09 amps AC	6.09 amps AC
Idle Power	Full	18 Watts	18 Watts	18 Watts
	Search	6 Watts	6 Watts	6 Watts
Typical Efficiency		90%	92%	93%
Total Harmonic Distortion	Typical	2%	2%	2%
	Maximum	5%	5%	5%
Output Voltage Regulation		± 2%	± 2%	± 2%
Maximum Output Current	Peak	28 amps AC	28 amps AC	28 amps AC
	RMS	20 amps AC	20 amps AC	20 amps AC
AC Overload Capability	Surge	4600 VA	4600 VA	4600 VA
	5 Second	2900 VA	2900 VA	2900 VA
	30 Minutes	1800 VA	2000 VA	2000 VA
AC Input Current Maximum		30 amps AC	30 amps AC	30 amps AC
AC Input Voltage Range (Adjustable)		140 to 280 VAC	140 to 280 VAC	140 to 280 VAC
AC Input Frequency Range		45 to 55 Hz	44 to 55 Hz	44 to 55 Hz
DC Input Voltage Range		10.5 to 17.0 VDC	21.0 to 34.0 VDC	42.0 to 68.0 VDC
Continuous Battery Charger Output		70 amps DC	40 amps DC	20 amps DC
Operating Temperature Range		-40° C to 60° C (power derated above 25° C)		
Warranty		Standard 2 year / Optional 5 year		
Weight	Unit	49.6 lbs (22.5 kg)		
	Shipping	56.35 lbs (25.56 kg)		
Dimensions (H x W x L)	Unit	13 x 8.25 x 16.25" (33 x 21 x 41 cm)		
	Shipping	21.75 x 13 x 22" (55 x 33 x 56 cm)		

• Specifications subject to change without notice.

OutBack Extreme Series

The OutBack Extreme Series Inverter/Charger is a highly reliable all-in-one power solution. Incorporating rugged components not available in regular commercial “off-the-shelf” inverter/chargers, the OutBack Extreme Series Inverter/Charger can survive harsh environmental conditions including extreme shaking and vibration.

Our true-sinewave inverter/charger uses intelligent battery charging and has an integrated AC transfer switch with automatic neutral-ground switching for mobile applications. The OutBack Extreme Series Inverter/Charger produces low-distortion AC power for all of your mobile electrical needs and industry-leading surge power starts multiple heavy loads simultaneously.

The OutBack Extreme Series Inverter/Charger is designed to meet your needs today, tomorrow and in the future. Our integrated building block architecture allows you to expand your system from 2 to 36 kW and user-defined settings allow your system to operate at 120 VAC, 120/240 VAC or 120Y208 VAC three-phase by stacking multiple inverter/chargers together.



OutBack Extreme Inverter/Charger Model Specifications

		OBX-IC2024S-120/60*	OBXG-IC2524P-120/60	OBX-IC3524P-120/60	OBX-IC2024P-230/50
Nominal DC Input Voltage		24 VDC	24 VDC	24 VDC	24 VDC
Continuous Power Rating at 25° C		2000 VA	2500 VA	3500 VA	2000 VA
AC Voltage/Frequency		120 VAC 60 Hz	120 VAC 60 Hz	120 VAC 60 Hz	230 VAC 50 Hz
Continuous AC RMS Output at 25° C		20.8 amps AC	20.8 amps AC	29.2 amps AC	8.7 amps AC
Idle Power	Full	20 Watts	20 Watts	20 Watts	20 Watts
	Search	6 Watts	6 Watts	6 Watts	2.6 Watts
Typical Efficiency		92%	92%	92%	92%
Total Harmonic Distortion	Inverting	2%	2%	2%	2%
	Selling	< 5%	< 5%	< 5%	< 5%
Output Voltage Regulation		± 2%	± 2%	± 2%	± 2%
Maximum Output Current	Peak	70 amps AC	70 amps AC	70 amps AC	35 amps AC
	RMS	50 amps AC	50 amps AC	50 amps AC	25 amps AC
AC Overload Capability	Surge	6000 VA	6000 VA	6000 VA	5750 VA
	5 Second	4800 VA	4800 VA	5000 VA	4800 VA
	30 Minutes	3200 VA	3200 VA	4000 VA	3100 VA
AC Input Current Maximum		30 amps AC	30 amps AC	60 amps AC	30 amps AC
AC Input Voltage Range (MATE Adjustable)		80 to 150 VAC	80 to 150 VAC	80 to 150 VAC	160 to 300 VAC
AC Input Frequency Range		54 to 66 Hz	54 to 66 Hz	54 to 66 Hz	44 to 56 Hz
DC Input Range		21.0 to 34.0 VDC	21.0 to 34.0 VDC	21.0 to 34.0 VDC	21.0 to 34.0 VDC
Continuous Battery Charge Output		55 amps DC	55 amps DC	85 amps DC	55 amps DC
Recommended Battery Cable		#2/0 AWG	#2/0 AWG	#2/0 AWG	#2/0 AWG
Recommended Battery Types		Flooded Lead Acid, AGM Gel			
Neutral Ground Switching		Yes	Yes	No	No
Chassis		Sealed/Fordable	Sealed	Vented	Sealed
Warranty		Standard 1 year	Standard 1 year	Standard 1 year	Standard 1 year
Weight	Unit	57.5 lbs (25 kg)	62 lbs (25 kg)	62 lbs (25 kg)	62 lbs (25 kg)
	Shipping	85 lbs (30 kg)	67 lbs (30 kg)	67 lbs (30 kg)	67 lbs (30 kg)
Dimensions (H x W x L)	Unit	13 x 8.25 x 16.25" (33 x 21 x 41 cm)		13 x 8.25 x 16.25" (33 x 21 x 41 cm)	
	Shipping	21.75 x 13 x 22" (55 x 33 x 56 cm)		21.75 x 13 x 22" (55 x 33 x 56 cm)	

* Optional AC wiring Kit (OBX-IC2024S-KIT) available for OBX-IC2024-120/60– (1EA) AC IN and AC OUT 6’ Automotive Maxi-connectors, (1EA) HUB/RTS, 6’ automotive Mini-connector with one connector and one raw end

• Specifications subject to change without notice.

The FLEXmax family of charge controllers is the latest innovation in Maximum Power Point Tracking (MPPT) charge controllers from OutBack Power Technologies. The innovative FLEXmax MPPT software algorithm is both continuous and active, increasing your photovoltaic array power yield up to 30% compared to non-MPPT controllers. Thanks to active cooling and intelligent thermal management cooling, both FLEXmax charge controllers can operate at their full maximum current rating, 60 amps or 80 amps respectively, in ambient temperatures as high as 104°F (40°C).

Included in all of the FLEXmax Charge Controllers are the revolutionary features first developed by OutBack Power, including support for a wide range of nominal battery voltages and the ability to step-down a higher voltage solar array to recharge a lower voltage battery bank. A built-in, backlit 80-character display shows the current status and logged system performance data for the last 128 days at the touch of a button. The integrated OutBack network communications allows FLEXmax Series Charge Controllers to be remotely programmed and monitored via a MATE system display and provides unrivaled complete system integration.

FLEXmax MPPT Charge Controllers are the only choice when you demand a high-performance, efficient and versatile charge controller for your advanced power system.



FLEXmax 80

FLEXmax 60

FLEXmax™ Specifications

Nominal Battery Voltages	12, 24, 36, 48, or 60 VDC (Single model - selectable via field programming at start-up)		
Maximum Output Current	60 amps @ 104° F (40°C) with adjustable current limit / 80 amps @ 104° F (40°C) with adjustable current limit		
Maximum Solar Array STC Nameplate	FLEXmax 60	12 VDC systems 900 Watts / 24 VDC systems 1800 Watts / 48 VDC systems 3600 Watts / 60 VDC systems 4500 Watts	
	FLEXmax 80	12 VDC systems 1250 Watts / 24 VDC systems 2500 Watts / 48 VDC systems 5000 Watts / 60 VDC systems 6250 Watts	
NEC Recommended Solar Array STC Nameplate	FLEXmax 60	12 VDC systems 750 Watts / 24 VDC systems 1500 Watts / 48 VDC systems 3000 Watts / 60 VDC systems 3750 Watts	
	FLEXmax 80	12 VDC systems 1000 Watts / 24 VDC systems 2000 Watts / 48 VDC systems 4000 Watts / 60 VDC systems 5000 Watts	
PV Open Circuit Voltage (VOC)	150 VDC absolute maximum coldest conditions / 145 VDC start-up and operating maximum		
Standby Power Consumption	Less than 1 Watt typical		
Power Conversion Efficiency - Typical	FLEXmax 60	98.1% @ 60 amps in a 48 VDC System	
	FLEXmax 80	97.5% @ 80 amps in a 48 VDC System	
Charging Regulation	Four Stages: Bulk, Absorption, Float, and Equalization		
Voltage Regulation Set points	10 to 80 VDC user adjustable with password protection		
Equalization Charging	Programmable Voltage Setpoint and Duration - Automatic Termination when completed		
Battery Temperature Compensation	Automatic with optional RTS installed / 5.0 mV per °C per 2V battery cell		
Voltage Step-Down Capability	Can charge a lower voltage battery from a higher voltage PV array - Max 150 VDC input		
Programmable Auxiliary Control Output	12 VDC output signal which can be programmed for different control applications (Maximum of 0.2 amps DC)		
Status Display	3.1" (8 cm) backlit LCD screen - 4 lines with 80 alphanumeric characters total		
Remote Display and Controller	Optional Mate or Mate2 with RS232 Serial Communications Port		
Network Cabling	Proprietary network system using RJ 45 Modular Connectors with CAT 5e Cable (8 wires)		
Data Logging	Last 128 days of Operation - Amp Hours, Watt Hours, Time in Float, Peak Watts, Amps, Solar Array Voltage, Max Battery Voltage Min Battery Voltage and Absorb for each day along with total Accumulated Amp Hours, and kW Hours of production		
Positive Ground Applications	Requires two Pole Breakers for switching both positive and Negative Conductors on both Solar Array and Battery Connections (HUB-4 and HUB-10 can not be used in positive ground applications)		
Operating Temperature Range	Minimum -40° to maximum 60° C (Power capacity of the controller is automatically derated when operated above 40° C)		
Environmental Rating	Indoor Type 1 (IP 30)		
Conduit Knockouts	One 1" (35mm) on the back; One 1" (35mm) on the left side; Two 1" (35mm) on the bottom		
Warranty	Standard 5 year		
Weight	Unit	FLEXmax 80	FLEXmax 60
	Shipping	12.20 lbs (5.56 kg)	11.65 lbs (5.3 kg)
		15.5 lbs (7.03 kg)	14.9 lbs (6.7 kg)
Dimensions	Unit (H x W x D)	FLEXmax 80	FLEXmax 60
		16.25" x 5.75" x 4.5" (41.3 x 14 x 10 cm)	13.75 x 5.75 x 4.5" (40 x 14 x 10 cm)
	Shipping	21" x 10.5" x 10.5" (53 x 27 x 27 cm)	18 x 11 x 8" (46 x 30 x 20 cm)
Options	Remote Temperature Sensor (RTS), HUB 4, HUB 10, MATE, MATE 2		
Menu Languages	English & Spanish		

• Specifications subject to change without notice. Use appropriate wire size in accordance with NEC.

System Display and Controller

MATE & MATE2

The MATE system display and controllers are complete management tools for your OutBack Power system. Through the use of a single MATE you can remotely manage and monitor multiple inverter/chargers, charge controllers and monitoring devices.

The MATE and MATE2 are packed full of features to make system management simple. The easy-to-read 3.1" (8 cm) LCD is backlit for dark operating conditions. Four soft keys allow easy context-based navigation of menus and functions. Two hot keys give immediate access to AC and inverter functions.

A built-in clock and calendar function enables timer-based programming of inverter and charger operation. This permits you to set the system to work with time-of-day power rates or to limit a generator's run time to a specific time period of the day or week. All of your settings are stored in permanent memory to eliminate the need to reprogram in the event of a system shutdown or battery replacement. The MATE and MATE2 include a RS232 port with DB9 jack for connection to the serial port of a PC computer. The MATE system display and controller is surface-mounted while the MATE2 is flush-mountable in a wall cut-out.



MATE



MATE2

MATE Specifications

MATE	Grey	Surface-mount
MATE_B	Black	Surface-mount
MATE2	Black	Flush mount
Interface Display	3.1" (8 cm) backlit LCD - four line, 80 alpha numeric characters	
Control Keypad	6 backlit silicone keys - dedicated inverter and AC input keys	
Status Indicators	Two LED Status Indicators - AC input (yellow), inverting (green)	
Communication Protocol	Proprietary OutBack Multi-drop using an OutBack HUB4 or HUB10	
Interconnection Cabling	Standard CAT 5 network cable with RJ45 modular jack - 10' (5 m) included	
PC Computer Interface	RS232 opto-isolated DB9 jack 9600 baud serial communication	
Microprocessor	16 MHz low power consumption version	
Set point and Data Memory	32K non-volatile flash RAM	
Clock / Calendar	On-board real time clock with battery backup	
Environmental Rating	Indoor Type 1 (IP 30)	
Maximum Cable Length	1000' (300 m)	
Warranty	Standard 2 year / Optional 5 year	
Weight	Shipping	1 lb (.5 kg)
Dimensions (H x W x L)	Shipping	5.75 x 4.25 x 2" (15 x 11 x 5 cm)



The OutBack Power Technologies FLEXnet™ DC is the ultimate in DC System monitoring devices. Our integrated networked communications make valuable, usable data available from your system, viewable on an OutBack MATE communications device (screens seen below), providing you with the answers you need concerning your system's health, performance and efficiency. The FLEXnet DC provides real state-of-charge (S.O.C.) information about the life and state of your battery bank.

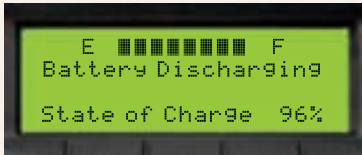

Battery Status Screen-Easily see your system's current condition with this at-a-glance display. This screen shows an easy-to-interpret "fuel gauge" style status bar, current state of charge and whether you are currently charging or discharging your batteries. This is useful for those system owners who want a way to quickly understand the current state of their battery bank.



Now Summary Screen-Monitor the amount of power your system is currently producing and consuming as well as the amount of power going IN and OUT of your battery bank. This screen also displays your battery bank's voltage and current state of charge, providing you with real-time production monitoring of DC sources, such as a solar array or small wind turbine, as well as consumption by loads.



Today Summary Screen-Monitor the cumulative energy your system has produced and consumed as well as the total amount of energy that has gone to charging your batteries today. This screen also displays today's lowest state of charge and allows you to see how your overall system production compares to system consumption.



History Summary Screen-Review historical energy production/consumption data for the most recent 128 days, including the minimum battery state of charge reached for each day. This screen can be used to watch power system production and consumption trends.

FN-DC Specifications

Battery Voltage Input Range		8.0 to 80.0 Volts DC
Battery Voltage Resolution		0.1 Volts DC
Number of Current Channels		One to Three (each can be a Source or Load)
Current Range (Each Channel)		-1000.0 amps to +1000.0 amps DC
Current Resolution		0.1 amps DC
State of Charge Display		0 to 100% (1% increments)
Aux Relay Configuration		SPST, Magnetic Latching Relay
Aux Relay Max Rating		5 amps @ 30 Volts DC
Current Shunt Type (order separately)		500 Amp / 50mv
Display	Primary	OutBack Power MATE or MATE2 4 x 20 LCD
	Secondary	Five LED Indicators on front of FLEXnet DC
Battery AH Capacity Range		100 to 10,000 amp Hours
Data Logging Memory		Most recent 128 Days
Programmable AUX Relay Settings	Battery Volts	Adjustable from 8.0 to 80.0 VDC
	State of Charge	Adjustable from 0 to 100%
	Time Delay	Adjustable from 0 to 240 Minutes
Accuracy		0.5% of Reading +/- 2 Least Significant Digits per channel
Operating Temperature Range		0 - 50°C
Mounting		3/4" Panel Mount Breaker Slot or Surface Mount
Warranty		Standard 2 year
Weight	Unit	5 oz. (.14kg)
	Shipping	2 lbs. (.90kg)
Dimensions (H x W x L)	Unit	0.74 x 3.72 x 6.60" (1.88 x 9.45 x 16.75 cm)
	Shipping	2.13 x 9 x 11.5" (5.4 x 22.86 x 29.21 cm)

* Specifications subject to change without notice. Use appropriate wire size in accordance with NEC.

Communications Manager

HUB

The HUB system communications managers are the backbone of your networked OutBack power conversion system. The OutBack HUB communicates stacking, load share and power save off/on signals. Interconnection cabling is standard Ethernet CAT5 with RJ45 modular jacks. Through the use of a HUB, your system is completely coordinated and managed by the MATE.



HUB Specifications

HUB Specifications		HUB4	HUB10
Number of Ports		4 Plus MATE	10 Plus MATE
Weight	Unit	1 lb (.5 kg)	1 lb (.5 kg)
	Shipping	3 lbs (1.4 kg)	3 lbs (1.4 kg)
Dimensions (H x W x L)	Unit	10.5 x 6.25 x 1.27" (27 x 16 x 3 cm)	10.5 x 6.25 x 1.27" (27 x 16 x 3 cm)
	Shipping	12 x 6 x 5" (31 x 15 x 13 cm)	12 x 6 x 5" (31 x 15 x 13 cm)

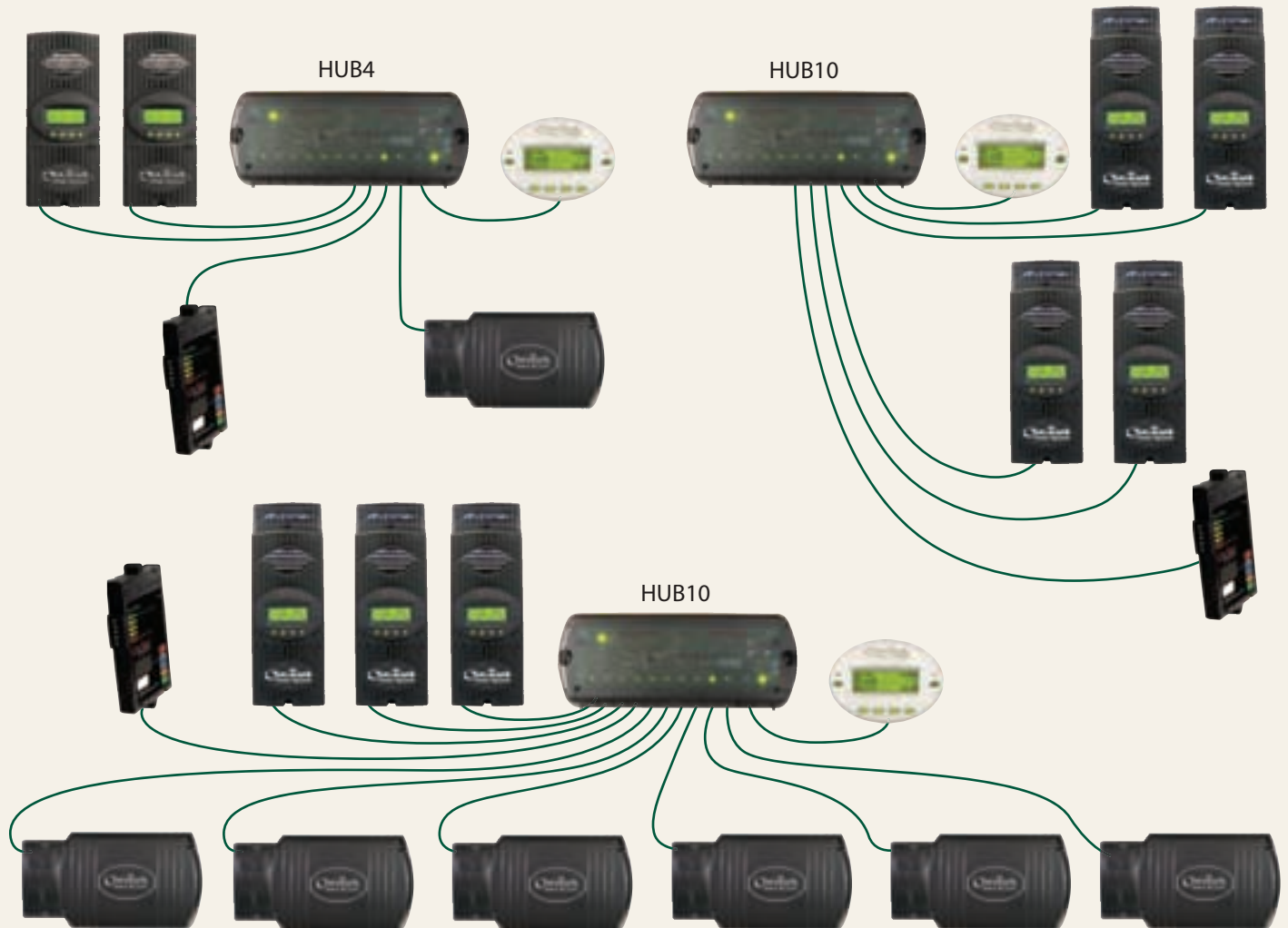

Remote Temperature Sensor

RTS

The OutBack Remote Temperature Sensor (RTS) is a necessary tool for proper battery charging. All OutBack products with integrated battery charging have a temperature compensation system built in which benefits from the installation of the RTS (included with inverter/chargers). The RTS ensures that your OutBack system knows the precise battery temperature so that it can recharge your batteries safely and efficiently. Systems with multiple OutBack products connected to one HUB4 or HUB10 require only a single RTS to be installed.

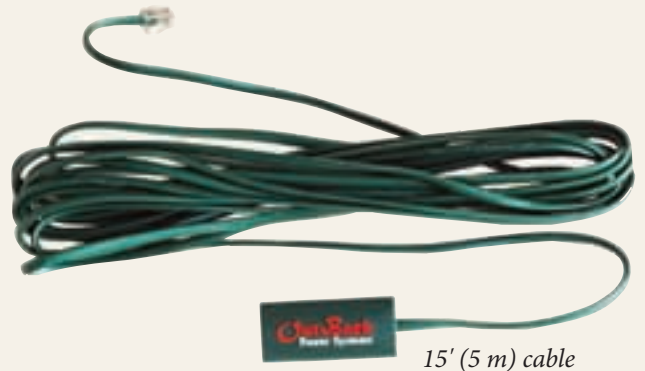

Multi-Stage Battery Charging

Batteries are a key component in backup and off-grid systems, often serving as the only energy storage device. To guarantee that they function properly it is important that your batteries are maintained. A chief part of this maintenance is proper charging. Your batteries should always be maintained above a 50% level of charge and receive a regular recharges once a month to ensure operation at peak performance. Prolonged use of the battery below a 50% state of charge will adversely affect the long-term health of the battery and can result in premature failure.

The multistage charging process (5 stages) uses several regulation stages to allow fast recharging of the battery energy storage system while ensuring a long battery life, high performance and efficient operation of the overall system. The charging process begins with the **BULK** stage, where maximum current is sent to the batteries until the target “absorb” voltage is reached and the absorb stage of the charge begins. During **ABSORB**, the charger provides the batteries with the just enough current to hold at the set voltage for a preset amount of time. Following this cycle, the charging system changes between available OutBack charging products. Using a FLEXmax Series

Charge Controller, the batteries enter the **FLOAT** stage where they are given a maintenance charge until there is no excess renewable energy. The FX or VFX inverter/charger will go into **SILENT** mode where the charger turns off until the battery voltage drops to the “re-float” setting. At this point the inverter/charger initiates the maintenance float charge. This method reduces fuel and utility consumption.

It should be noted that the temperature of your batteries has an impact on the charging process. The OutBack RTS should be used to monitor this. In higher ambient temperatures, the battery charging regulation settings will be automatically reduced to prevent overcharging of the batteries. Conversely, in lower ambient temperature conditions, the regulation

settings will be increased to ensure complete recharging of the batteries. Batteries are composed of a group of individual cells. Through normal use, the charge of each individual cell will not be equal to the other cells. To address this, your batteries should be **EQUALIZED** either once each month or once every few months depending on usage. During the equalization charge the electrolyte in the battery is stirred up by gas bubbles, which help to create an equal mixture of water and acid. Simultaneously the full cells are overcharged which allows the low cells to “catch up” and all of the active material in the battery to be reconverted to its charged state. Depending on usage, the hardened battery plate material that is no longer active in the battery-sulfation can also be reduced by an equalization charge.

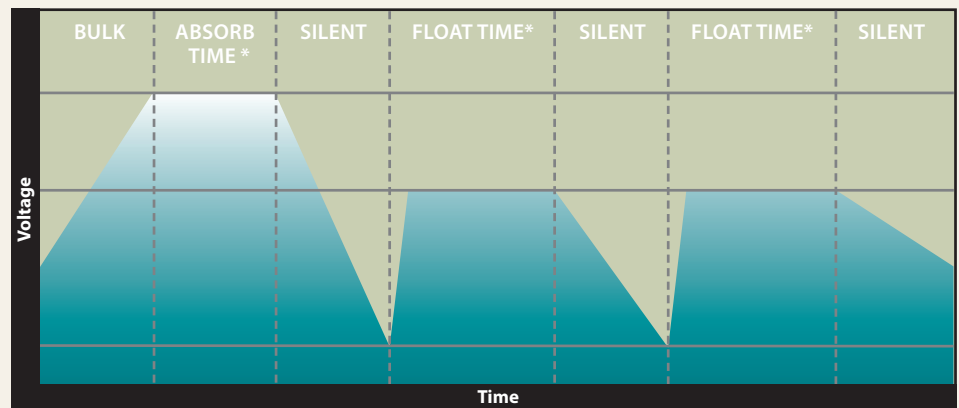

*MATE Adjustable

FLEXware™ Surge Protector

The OutBack Power Technologies FLEXware Surge Protector is a seamlessly integrated balance-of-system component for the FX Series Inverter/Charger. The FLEXware Surge Protector was designed by OutBack engineers specifically for OutBack FX Series Inverter/Chargers, and provides multiple levels of protection for the vital electrical components of the Inverter/Charger in the event of an electrical surge. The sophisticated design allows for both AC and DC protection on multiple circuits (two AC and one DC) via thermally fused Metal Oxide Varistors (MOVs). LED visual indicators provide at-a-glance status monitoring allowing system users to determine FLEXware Surge Protector operational status in real-time. The FLEXware Surge Protector is designed to operate between 120 to 240 VAC at 50/60 Hz and 12 to 48 VDC. Its multiple mounting configurations allow it to be incorporated into any OutBack system. The FW-SP-ACA mounts inside the FW-ACA for FLEXware 500 and 1000 systems, while the FW-SP-250 is designed to mount inside the FLEXware 250 AC Side Breaker Enclosure allowing for quick installations that keep your system protected and looking great.



The OutBack Power Technologies FLEXware Surge Protector is the only choice when you want to protect your FX Series Inverter/Charger from the harmful effects of transient power surges. Ease of installation and seamless integration make it the obvious addition to your OutBack system.

FLEXware™ Surge Protector Specifications

		FW-SP-ACA	FW-SP-250	FW-SP-R
Nominal Voltage		120-240VAC/12-48VDC	120-240VAC/12-48VDC	120-240VAC/12-48VDC
Voltage Protection Level		390VAC/150VDC	390VAC/150VDC	390VAC/150VDC
AC or DC		AC/DC	AC/DC	AC/DC
Maximum Surge Current (8/20 μs)		30kA per circuit	30kA per circuit	30kA per circuit
Energy Rating		2500 joules	2500 joules	2500 joules
Frequency		50/60 Hz	50/60 Hz	50/60 Hz
Protection Type		Thermally Fused MOV	Thermally Fused MOV	Thermally Fused MOV
Number of Protected Circuits		Two AC & One DC	Two AC & One DC	Two AC & One DC
Mounting		FW-ACA	FW-250	Replacement Board (FW-SP-ACA, FW-SP-250)
Weight	Unit	1 lbs 4 oz (.57 kg)	1 lbs 2.5 oz (.52 kg)	7.5 oz (.21 kg)
	Shipping	2 lbs 2 oz (.96 kg)	2 lbs (.91 kg)	1 lb 2.2 oz (.516 kg)
Dimensions (H x W x L)	Unit	8.5 x 6.75 x 2.5" (21.59 x 17.15 x 6.35 cm)	5.5 x 6.5 x 7.5" (13.97 x 16.51 x 19.05 cm)	7.75 x 5.5 x 1.5" (19.69 x 13.97 x 3.81 cm)
	Shipping	10.13 x 9.13 x 5.75" (25.72 x 23.2 x 14.6 cm)	10 x 7.25 x 6" (25.4 x 18.42 x 15.24 cm)	9.38 x 7.25 x 2.5" (23.81 x 18.42 x 6.35 cm)

Stacking

At OutBack, we adhere to a philosophy that a power system should be fully customizable to address your specific needs. Therefore we set out to create the world's first group of inverter/chargers that use a truly modular architecture. This modular architecture uses the next generation of a technique referred to as "stacking" to enable you to tailor your system for higher output power, increased charging capabilities and/or three-phase power configuration.

Whether stacked in parallel, classic series, series/parallel or three-phase there is always an inverter/charger which performs the task of Master. The Master talks to the other units through the HUB system communications manager while performing three major roles, keeping all inverter/chargers properly phased, controlling inverter and charger output levels, as well as putting unused inverters into Power Save mode to improve system efficiency at low AC load levels.

Parallel Stacking - More power at same output voltage

When the inverter/chargers are stacked in parallel all inverter and charger outputs are combined. This means that each inverter's AC output is added up to equal your total system AC output, up to 36,000 watts, in phase at the same 120 VAC/60 Hz or 230 VAC/50 Hz output voltage. Charging output amperage is also combined in this same manner.



Classic Series Stacking - More power at higher output voltage

Stacking inverter/chargers in classic series provides a system with split phase 120/240VAC. This method does not allow balancing between separate legs on a system and is can only be used in dual inverter/charger systems without the X-240 Auto Transformer.

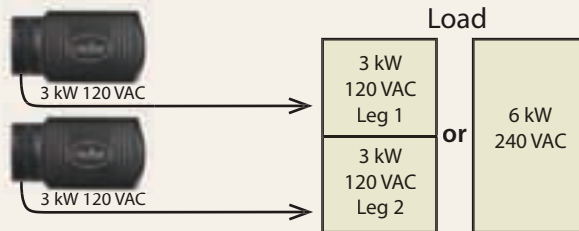

OutBack Series/Parallel Stacking - More power at all output voltages

Series/Parallel stacking or OutBack (OB) stacking is unique to OutBack inverter/chargers. Never before has it been possible to have inverter/chargers balancing loads intelligently between two legs of AC power while seamlessly changing between series and parallel. OB Stacking uses the X-240 auto transformer to balance the loads between the two separate series legs of a system. The X-240 allows AC loads on leg 1 and leg 2 to be powered by any combination of inverter/chargers within your system. Even if there are only two inverter/chargers, connected in series, they can function as if connected in parallel. This allows larger AC loads to be operated by a system without risking overloading one of the 120 VAC outputs.

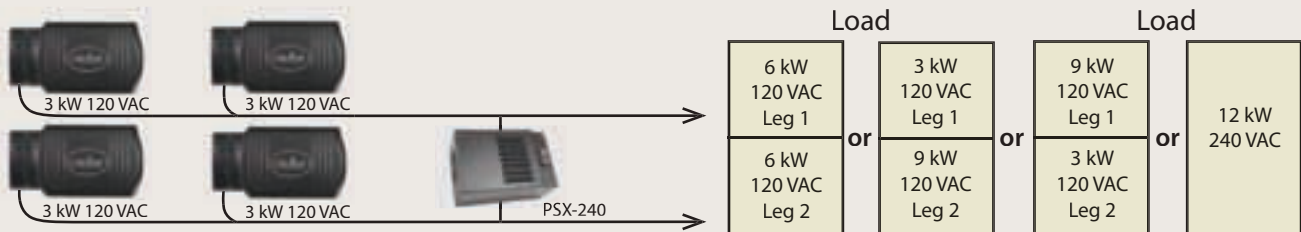

3-Phase Stacking - More power for three-phase loads

Three inverter/chargers can be configured to provide 120/208 VAC or 230/400VAC four wire "WYE/Star" three-phase AC Power. An inverter/charger is used to power each of the three legs for 3-phase AC power. The loads on each of the inverters do not need to be kept balanced - each phase is independently voltage regulated.

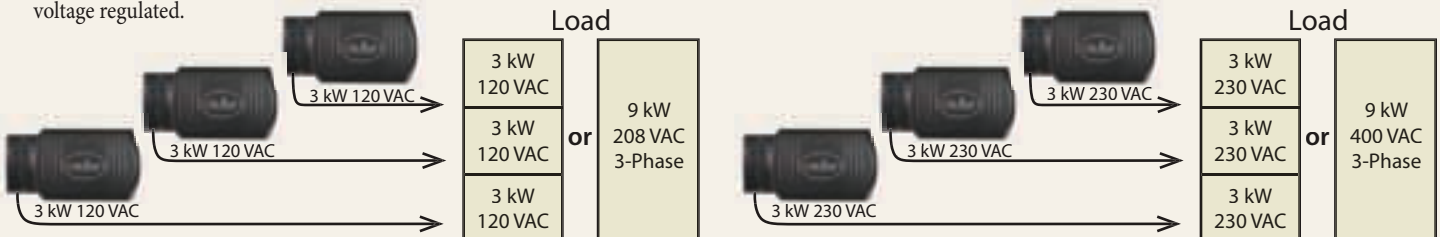

Auto Transformer



PSX-240

The OutBack PSX-240 (6 kVA) auto transformer can be used for step-up, step-down, generator and split-phase output balancing or as a series stacked inverter to load balancing autoformer. Incorporating a transformer with 120 volt/30 amp primary and secondary side, a temperature activated cooling fan and a 25 amp dual breaker in a steal enclosure, the PSX-240 is ready to install in your custom application. Use for 120 or 240 VAC 60 Hz systems only.

Powering 240 volt items like deep well pumps with a single 120 volt inverter is possible thanks to the PSX-240's step-up capability. Its step-down feature allows you to charge your batteries with a 240 volt generator through a single 120 volt inverter. The PSX-240's ability to balance the output of series stacked inverter/chargers makes it a critical item when using the OutBack stacking 120/240 VAC configuration.

The FW-X240 (4 kVA) is also available without the enclosure, for installation inside the FW500-AC or FW1000-AC enclosures.

Specifications

		PSX-240	FW-X240
Weight	Unit	37.7 lb (17.1 kg)	28.4 lb (12.9 kg)
	Shipping	39.5 lbs (17.9 kg)	32.5 lbs (14.7 kg)
Dimensions (H x W x L)	Unit	6.25 x 8 x 12.5" (15.9 x 20.3 x 31.75 cm)	5.25 x 6 x 6.5" (27 x 16 x 3 cm)
	Shipping	10.25 x 12.25 x 16.25" (26 x 31.1 x 33 cm)	10.75 x 10.75 x 10.75" (27 x 27 x 27 cm)

Step-Up



Step-Down

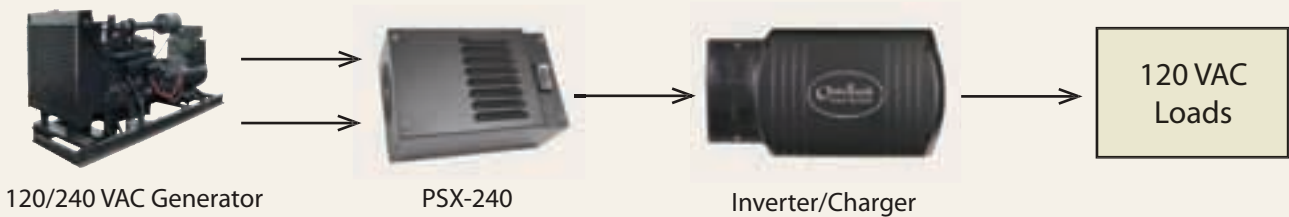

Generator Balancing

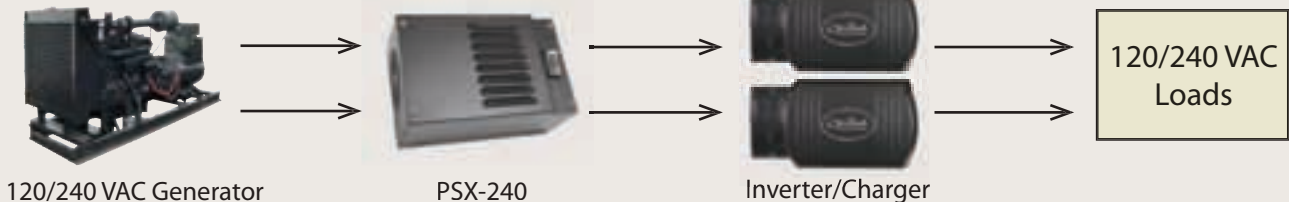

OutBack Balancing

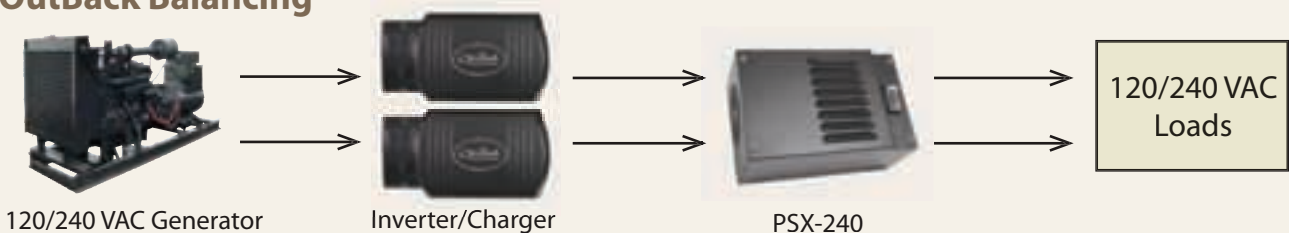

For applications with modest power requirements such as cabins, chalets, homes, remote communication sites and back-up power systems. The FLEXware 250 accommodates all of the essential protective devices in the smallest possible space at the lowest installed cost. Utilizing an extremely compact design and unique mounting features, **one or two** FLEXware 250 enclosures can be mounted on each end of a single FX Series Inverter/Charger. The FLEXware 250 enclosure is constructed of powder-coated aluminum is ETL listed. It provides breaker spaces for battery, PV array or PV GFDI breakers and mounting locations for AC GFCI outlet, AC breakers and an Input-Output-Bypass Assembly. In keeping with the philosophy of FLEXware, the FLEXware 250's flexibility is evident in the generous number of knock-outs allowing the installation of conduit, cable glands, and other installation accessories.



Breaker Configuration Diagram

AC Side

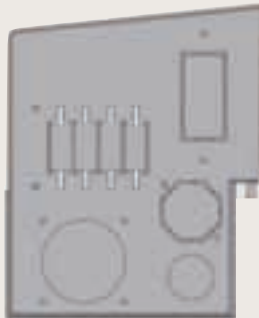

Holds up to four 0.75" (19 mm) wide AC rated panel mount breakers (not included with bare chassis) rated for 1-60 amps of AC current. Provision for optional AC Input-Output-Bypass Assembly. Holds one 120 V U.S. outlet receptacle and one 230 V European outlet receptacle.

New feature includes:

Terminal busbar to accommodate an isolated neutral bus in AC applications.

DC Side

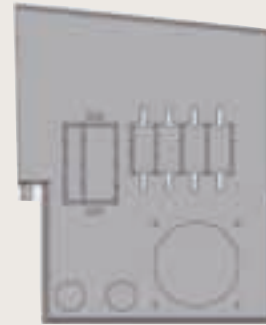

Holds up to four 0.75" (19 mm) wide DC rated panel mount breakers (not included with bare chassis) rated for 1-80 amps of DC current. Holds one 1.5" (39 mm) wide 175 or 250 amp breaker, or one 1.02" (26 mm) wide 100 or 125 amp breaker. Includes large DC breaker handle guard.

New feature includes:

DC negative bus for DC applications.

Knockout Location Diagram

AC Side

- (1) 2" knockout (2.468" diameter)
- (1) 1" knockout (1.359" diameter)

DC side

- (1) 2" knockout (2.468" diameter)
- (2) ½" knockout (0.875" diameter)

Front

- (1) 2" knockout (2.468" diameter)
- (2) 1" knockout (1.359" diameter)

Bottom

- (1) 1½" knockout (.875" diameter)

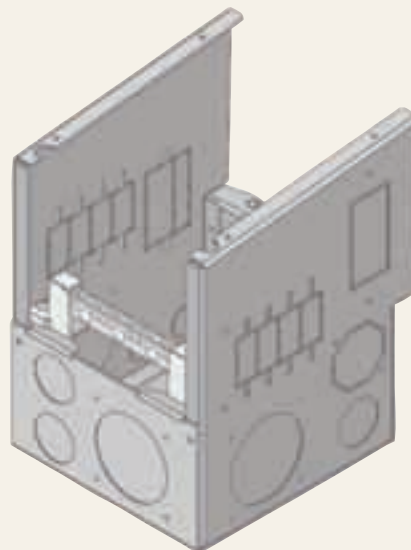

FLEXware 250

Model: FW250

Description: DC and/or AC breaker enclosure for one FX Series Inverter/Charger

Includes: Ground bus bar, DC breaker handle guard, breaker mounting hardware and enclosure mounting hardware

Unit Dimensions (H x W x D)	Shipping Dimensions (H x W x L)	Shipping Weight	Enclosure Type
7.5 x 6.5 x 8.6" (19.1 x 16.5 x 21.8 cm)	9.75 x 8.4 x 11.6" (24.8 x 21.3 x 29.5 cm)	5 lbs. (2.3 kg)	Type-1 indoor (IP30)

Holds up to eight 1 to 80 amp, one 175 or 250 amp panel mount breaker and a GFCI AC outlet (not included).

- Does not use the DCA or FW-ACA for connection to an FX Series Inverter/Charger.
- DC current shunt not included

FLEXware 250 AC Input-Output-Bypass Assemblies

Field-installable kit for by-passing the AC input to the AC output for inverter maintenance, testing or installation. Also provides over-current protection for AC input and output.

Model: FW-IOB-S-120VAC

Includes: Three 60A 120VAC single pole PANEL mount breakers, sliding bypass interlock plate, wire and hardware kit

System Rating	Bypass Breaker	Input Breaker	Output Breaker
Single-Phase 120VAC 60 amp 7.2 kW	One Pole @ 60 amps 7.2 kW	One Pole @ 60 amps 7.2 kW	One Pole @ 60 amps 7.2 kW

Model: FW-IOB-S-230VAC

Includes: Three 30A 230VAC single pole PANEL mount breakers, sliding bypass interlock plate, wire and hardware kit

System Rating	Bypass Breaker	Input Breaker	Output Breaker
Single-Phase 230VAC 30 Amp 6.9 kW	One Pole @ 30 amps 6.9 kW	One Pole @ 30 amps 6.9 kW	One Pole @ 30 amps 6.9 kW

Sample Bill of Materials

FW250 With FW-IOB-S-120VAC - Example of system with one VFX3524 OutBack Power Inverter/Charger

Part #	Description	Qty
VFX3524 Inverter/Charger	3500 W, 24 VDC, 85 Amp charger, 60 Amp AC input	1
FW250	DC and/or AC breaker enclosure – secures directly to either end of an FX Series Inverter/Charger.	2
OBB-175-125VDC-PNL	175 Amp, 125VDC, 3/8" stud terminals	1
FW-IOB-S-120VAC	Single inverter Input-Output-Bypass for FW250 only	1
MATE	System Display and Controller	1
HUB-4	Four Port, Up to 4 devices and one MATE	1
FW-SHUNT250	500 Amp 50mV DC current shunt with attached terminal bus bar for mounting on top of a FX Series Inverter/Charger	1
FW-Cable175-15R	175 Amp 4/0 AWG DC cable 15 inches (380 mm) long with ring terminals on both ends with red heat shrink	1

FW250 With FW-IOB-S-230VAC - Example of system with one VFX3024E OutBack Power Inverter/Charger

Part#	Description	Qty
VFX3024E	3000 W, 24VDC, 85 Amps DC charger, 30 Amps AC input	1
FW250	DC and/or AC breaker enclosure - secures directly to either end of an FX series	2
OBB-250-125VDC-PNL	250 Amp, 125VDC, 3/8" stud terminals	1
FW-IOB-S-230VAC	Single inverter Input-Output-Bypass for FW250 only	1
MATE	System display and Controller	1
HUB4	Four Port, up to 4 devices and one MATE	1
FW-SHUNT250	500 Amp 50mV DC current shunt with attached terminal bus bar for mounting on top of a FX Series Inverter/Charger	1
FW-Cable250-15R	250 Amp 2/0 AWG DC cable 15 inches (380 mm) long with ring terminals on both ends with red heat shrink	1

FLEXware™ 500

For applications with medium power requirements such as homes, light commercial or larger back-up power systems. The FLEXware 500 system architecture can support up to two OutBack FX Series Inverter/Chargers, up to two OutBack charge controllers and all the associated AC and DC components. Thanks to a very compact design, FLEXware 500 AC and DC enclosures mount with a



FLEXware MP in either a horizontal or vertical orientation to allow installation in more space-limited locations for a fast and professional-looking wall-mounted installation. The FLEXware 500 accommodates all of the essential protective devices in two enclosures. The FLEXware 500 enclosure is constructed of powder-coated aluminum and has been ETL listed.

Breaker Configuration Diagram

AC Side



Holds up to sixteen DIN mount AC breakers (not included). Support for optional AC Input-Output-Bypass Assembly. AC breakers are rated from 10-16 amps of AC current.

DC Side

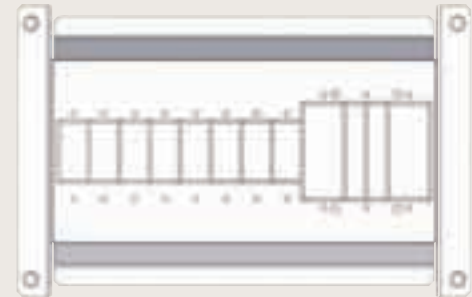

Holds up to eight 0.75" (19 mm) wide breakers rated for 180 amps of DC current, three 1" (26 mm) wide breakers rated for 100 or 125 amps of DC current, or two 1.5" (32 mm) wide breakers rated for 175 or 250 amps of DC current.

Knockout Location Diagram

Back

- (2) 2" knockout (2.468" diameter)

Left

- (5) 1" knockout (1.359" diameter)
- (2) 2" knockout (2.468" diameter)
- (2) Duplex GFCI Outlet knockout

Right

- (9) 1" knockout (1.357" diameter)

Top

- (3) 1" knockout (1.359" diameter)
- (1) ¾" knockout (1.093" diameter)
- (4) 2" knockout (2.468" diameter)

Bottom

- (3) 1" knockout (1.359" diameter)
- (1) ¾" knockout (1.093" diameter)
- (4) 2" knockout (2.468" diameter)

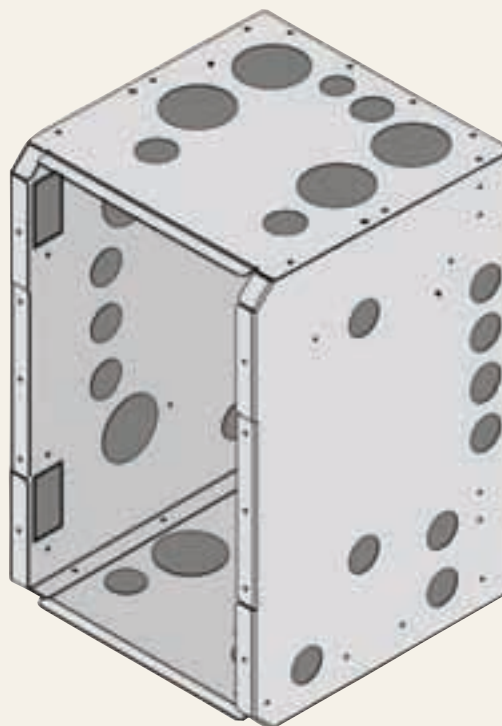

FLEXware 500

Model: FW500-DC

Description: DC enclosure which mounts at the DC side of one or two FX Series Inverter/Chargers. Supports up to six terminal bus bars (not including GBB) and up to three shunt assemblies depending on configuration

Includes: Ground bus bar, 500 amp DC shunt assembly, positive bus, breaker mounting hardware, FW-BBUS and enclosure mounting hardware

Unit Dimensions (H x W x D)	Shipping Dimensions (H x W x L)	Shipping Weight	Enclosure Type
18.2 x 11.4 x 12.1" (46.2 x 29 x 30.7 cm)	14.5 x 13.4 x 20.3" (36.8 x 34.1 x 51.6 cm)	15 lbs. (6.8 kg)	Type-1 indoor (IP30)

Model: FW500-AC

Description: AC enclosure which mounts at the AC side of one or two FX Series Inverter/Chargers. Supports six terminal bus bars and one FW-X240

Includes: Ground bus bar, DIN mounting bracket, communication cable conduit and enclosure mounting hardware

Unit Dimensions (H x W x D)	Shipping Dimensions (H x W x L)	Shipping Weight	Enclosure Type
18.2 x 11.4 x 12.1" (46.2 x 29 x 30.7 cm)	14.5 x 13.4 x 20.3" (36.8 x 34.1 x 51.6 cm)	15 lbs. (6.8 kg)	Type-1 indoor (IP30)

- The FW500 system utilizes one FW-MP (mounting plate) and a set of the DCA and FW-ACA conduit adapters for each inverter/charger.
- DC and AC breakers, Input-Output-Bypass Assemblies and all other additional components sold separately.

FLEXware 500 AC Input-Output-Bypass Assemblies

Field-installable kit for bypassing the AC input to the AC output for inverter maintenance or installation. Also provides over-current protection.

Model: FW-IOB-D-120/240VAC

Includes: Six 60A 120VAC single pole DIN mount breakers, sliding bypass interlock plate, wire and hardware kit

System Rating	Bypass Breaker	Input Breaker	Output Breaker
Split Phase 120/240 VAC 60 amps 14.4 kW	Two Poles @ 60 amps 14.4 kW	Two Poles @ 60 amps 14.4 kW	Two Poles @ 60 amps 14.4 kW

Model: FW-IOB-D-120VAC

Includes: Four 60A 120VAC single pole DIN mount breakers, one 60A 120VAC dual pole DIN mount breaker, sliding bypass interlock plate, wire and hardware kit

System Rating	Bypass Breaker	Input Breaker	Output Breaker
Single-Phase 120 VAC 120 amps 14.4 kW	Two Poles @ 60 amps 14.4 kW	Two Poles @ 60 amps 14.4 kW	Two Poles @ 60 amps 14.4 kW

Model: FW-IOB-D-230VAC

Includes: Six 30A 230VAC single pole DIN mount breakers, sliding bypass interlock plate, wire and hardware kit

System Rating	Bypass Breaker	Input Breaker	Output Breaker
Single-Phase 230 VAC 60 amps 13.8 kW	Two Poles @ 30 amps 13.8 kW	Two Poles @ 30 amps 13.8 kW	Two Poles @ 30 amps 13.8 kW

Sample Bill of Materials

FW500 With FW-IOB-D-120VAC - Example of system with one VFX3648 Outback Power Inverter/Charger

Part #	Description	Qty
VFX3648 Inverter/Charger	3600 W, 48 VDC, 45 Amp charger, 60 Amp AC input	1
FW-ACA	AC Conduit Adapter for all FX Series Inverter/Chargers to AC enclosure.	1
DCA	DC Conduit Adapter for all FX Series Inverter/Chargers to DC enclosure.	1
FW500-DC	DC breaker enclosure – fits at the DC side of one or two FX Series Inverter/Chargers	1
OBB-175-125VDC-PNL	175 Amp, 125VDC breaker with 3/8" stud terminals	1
FW500-AC	AC breaker enclosure – fits at the AC side of one or two FX Series Inverter/Chargers	1
FW-IOB-D-120VAC	Dual inverter Input-Output-Bypass for FW500	1
FW-MP	Mounting Plate for FW500 or FW1000 system	1
MATE	System Display and Controller	1
HUB4	Four Port, Up to 4 devices and one MATE	1
FW-Cable175-36R	175 Amp 2/0 AWG DC cable 36 inches (915 mm) long with ring terminals on both ends with red heat shrink	1
FW-Cable175-36W	175 Amp 2/0 AWG DC cable 36 inches (915 mm) long with ring terminals on both ends with white heat shrink	1

FW500 With FW-IOB-D-120/240VAC - Example of system with dual VFX3648 Outback Power Inverter/Chargers in Series

Part #	Description	Qty
VFX3648 Inverter/Charger	3600 W, 48 VDC, 45 amp charger, 60 amp AC input	2
FW-ACA	AC Conduit Adapter for all FX Series Inverter/Chargers to AC enclosure.	2
DCA	DC Conduit Adapter for all FX Series Inverter/Chargers to DC enclosure.	2
FW500-DC	DC breaker enclosure – fits at the DC side of one or two FX Series Inverter/Chargers	1
OBB-175-125VDC-PNL	175 amp, 125VDC breaker with 3/8" stud terminals	2
FW500-AC	AC breaker enclosure – fits at the AC side of one or two FX Series Inverter/Chargers	1
FW-IOB-D-120/240VAC	Dual inverter Input-Output-Bypass for FW500	1
FW-MP	Mounting Plate for FW500 or FW1000 system	1
MATE	System Display and Controller	1
HUB4	Four Port, Up to 4 devices and one MATE	1
FW-X240	Autotransformer 4 kVA 120/240VAC 60Hz	1
FW-Cable175-36R	175 amp 2/0 AWG DC cable 36 inches (915 mm) long with ring terminals on both ends with red heat shrink	2
FW-Cable175-36W	175 amp 2/0 AWG DC cable 36 inches (915 mm) long with ring terminals on both ends with white heat shrink	2

FW500 With FW-IOB-D-230VAC - Example of system with dual VFX3024E OutBack Power Inverter/Charger in Parallel

Part#	Description	Qty
VFX3024E	3000 W, 24VDC, 85 amps DC charger, 30 amps AC input	2
FW-ACA	AC Conduit adapter for all FX Series Inverter/Chargers to AC enclosure	2
DCA	DC Conduit adapter for all FX Series Inverter/Chargers to DC enclosure	2
FW500-DC	DC breaker enclosure - fits at the DC side of one or two FX Series Inverter/Chargers	1
OBB-250-125VDC-PNL	250 amp, 125VDC, 3/8" stud terminals	2
FW500-AC	AC breaker enclosure - fits at the AC side of one or two FX Series Inverter/Chargers	1
FW-IOB-D-230VAC	Dual inverter Input-Output-Bypass for FW500	1
FW-MP	Mounting Plate for FW500 or FW1000 System	1
MATE	System display and Controller	1
HUB4	Four Port, up to 4 devices and one MATE	1
FW-Cable175-36R	175 amp 2/0 AWG DC cable 36 inches (915 mm) long with ring terminals on both ends with red heat shrink	2
FW-Cable175-36W	175 amp 2/0 AWG DC cable 36 inches (915 mm) long with ring terminals on both ends with white heat shrink	2

FLEXware™ 1000

For applications with large power requirements such as large residential, commercial or village power systems. The FLEXware 1000 system architecture is capable of supporting up to four OutBack FX Series Inverter/Chargers, four OutBack charge controllers, and all the required AC and DC components and wiring. Utilizing a compact design, FLEXware 1000 AC and DC enclosures accommodate all of the essential protective devices with lots of room for additional breakers and large cable connections and can be mounted either vertically or horizontally.



Breaker Configuration Diagram

AC Side

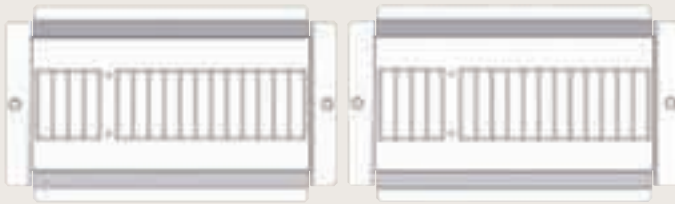

Holds up to thirty-two DIN mount AC breakers (not included). Support for optional AC Input-Output-Bypass Assembly. AC breakers are rated from 10-60 amps of AC current.

DC Side

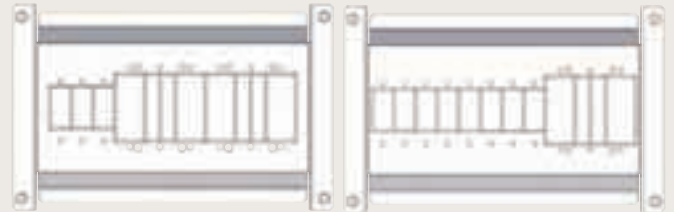

Holds up to eleven 0.75" (19 mm) wide breakers rated for 1-80 amps of DC current, nine 1" (26 mm) wide breakers rated for 100 or 125 amps of DC current or six 1.5" (32 mm) wide breakers rated for 175 or 250 amps of DC current.

Knockout Location Diagram

Left

- (4) 2" knockout (2.468" diameter)
- (9) 1" knockout (1.359" diameter)
- (2) Duplex GFCI Outlet knockout

Back

- (2) 2" knockout (2.468" diameter)
- (2) 1" knockout (1.359" diameter)

Right

- (17) 1" knockout (1.359" diameter)

Top

- (3) 1" knockout (1.359" diameter)
- (1) ¾" knockout (1.093" diameter)
- (4) 2" knockout (2.468" diameter)

Bottom

- (3) 1" knockout (1.359" diameter)
- (1) ¾" knockout (1.093" diameter)
- (4) 2" knockout (2.468" diameter)

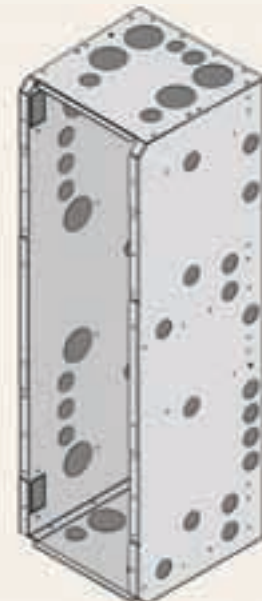

This information is a sample only – additional system configurations and components are available.

FLEXware 1000

Model: FW1000-DC

Description: DC enclosure which mounts at the DC side of three or four FX Series Inverter/Chargers. Supports up to eight terminal bus bars (not including GBB) and up to three shunt assemblies depending on configuration

Includes: Ground bus bar, 1000 amp DC shunt assembly, positive bus, breaker mounting hardware, enclosure mounting hardware, two FW-SBUSs and one FLEXware 1000 breaker bus

Unit Dimensions (H x W x D)	Shipping Dimensions (H x W x L)	Shipping Weight	Enclosure Type
38.5 x 11.4 x 12.1" (97.8 x 29.0 x 30.7 cm)	14.5 x 13.6 x 40.6" (36.8 x 34.5 x 103.1 cm)	21 lbs. (9.5 kg)	Type-1 indoor (IP30)

Model: FW1000-AC

Description: AC enclosure which mounts at the AC side of three or four FX Series Inverter/Chargers. Supports eight terminal bus bars and one FW-X240

Includes: Ground bus bar, two DIN mounting brackets and FLEXware 1000 wiring raceway

Unit Dimensions (H x W x D)	Shipping Dimensions (H x W x L)	Shipping Weight	Enclosure Type
38.5 x 11.4 x 12.1" (97.8 x 29.0 x 30.7 cm)	14.5 x 13.6 x 40.6" (36.8 x 34.5 x 103.1 cm)	21 lbs. (9.5 kg)	Type-1 indoor (IP30)

- The FW1000 system utilizes two FW-MPs (mounting plates) and a set of the DCA and FW-ACA conduit adapters for each inverter/charger.
- DC and AC breakers, Input-Output-Bypass Assemblies and all other additional components sold separately.

FLEXware 1000 AC Input-Output-Bypass Assemblies

Field installable kit for bypassing the AC input to the AC output for inverter maintenance or installation. Also provides over-current protection.

Model: FW-IOB-T-120/208VAC

Includes: Nine 60A 120VAC single pole DIN mount breakers, sliding bypass interlock plate, wire and hardware kit

System Rating	Bypass Breaker	Input Breaker	Output Breaker
Three-Phase 120/208 VAC 60 amps 21.6 kW	Three Poles @ 60 amps 21.6 kW	Three Poles @ 60 amps 21.6 kW	Three Poles @ 60 amps 21.6 kW

Model: FW-IOB-T-230/400VAC

Includes: Nine 30A 230VAC single pole DIN mount breakers, sliding bypass interlock plate, wire and hardware kit

System Rating	Bypass Breaker	Input Breaker	Output Breaker
Three-Phase 230/400 VAC 30 amps 20.7 kW	Three Poles @ 30 amps 20.7 kW	Three Poles @ 30 amps 20.7 kW	Three Poles @ 30 amps 20.7 kW

Model: FW-IOB-Q-120/240VAC

Includes: Eight 60A 120VAC single pole DIN mount breakers, two 60A 120VAC dual pole DIN mount breakers, sliding bypass interlock plate, wire and hardware kit

System Rating	Bypass Breaker	Input Breaker	Output Breaker
Split Phase 120/240 VAC 120 amps 28.8 kW	Four Poles @ 60 amps 28.8 kW	Four Poles @ 60 amps 28.8 kW	Four Poles @ 60 amps 28.8 kW

Model: FW-IOB-Q-230VAC

Includes: Twelve 30A 230VAC single pole DIN mount breakers, sliding bypass interlock plate, wire and hardware kit

System Rating	Bypass Breaker	Input Breaker	Output Breaker
Single-Phase 230 VAC 120 amps 27.6 kW	Four Poles @ 30 amps 27.6 kW	Four Poles @ 30 amps 27.6 kW	Four Poles @ 30 amps 27.6 kW

Sample Bill of Materials

FW1000 With FW-IOB-D-120VAC - Example of system with two VFX3648 Outback Power Inverter/Chargers in Parallel

Part #	Description	Qty
VFX3648 Inverter/Charger	3600 W, 48 VDC, 45 Amp charger, 60 Amp AC input	2
FW-ACA	AC Conduit Adapter for all FX Series Inverter/Chargers to AC enclosure.	2
DCA	DC Conduit Adapter for all FX Series Inverter/Chargers to DC enclosure.	2
FW1000-DC	DC breaker enclosure – fits at the DC side of up to four FX Series Inverter/Chargers	1
OBB-175-125VDC-PNL	175 Amp, 125VDC breaker with 3/8" stud terminals	2
FW1000-AC	AC breaker enclosure – fits at the AC side of up to four FX Series Inverter/Chargers	1
FW-IOB-D-120VAC	Quad inverter Input-Output-Bypass for FW1000	1
FW-MP	Mounting Plate for FW500 or FW1000 system	2
MATE	System Display and Controller	1
HUB-10	Ten Port, Up to 10 devices and one MATE	1
FW-Cable175-36R	175 Amp 2/0 AWG DC cable 36 inches (915 mm) long with ring terminals on both ends with red heat shrink	2
FW-Cable175-36W	175 Amp 2/0 AWG DC cable 36 inches (915 mm) long with ring terminals on both ends with white heat shrink	2

FW1000 With FW-IOB-D-120/240VAC - Example of system with two VFX3648 Outback Power Inverter/Chargers in Series

Part #	Description	Qty
VFX3648 Inverter/Charger	3600 W, 48 VDC, 45 Amp charger, 60 Amp AC input	2
FW-ACA	AC Conduit Adapter for all FX Series Inverter/Chargers to AC enclosure.	2
DCA	DC Conduit Adapter for all FX Series Inverter/Chargers to DC enclosure.	2
FW1000-DC	DC breaker enclosure – fits at the DC side of up to four FX Series Inverter/Chargers	1
OBB-175-125VDC-PNL	175 Amp, 125VDC breaker with 3/8" stud terminals	2
FW1000-AC	AC breaker enclosure – fits at the AC side of up to four FX Series Inverter/Chargers	1
FW-IOB-D-120/240VAC	Quad inverter Input-Output-Bypass for FW1000	1
FW-MP	Mounting Plate for FW500 or FW1000 system	2
MATE	System Display and Controller	1
HUB-10	Ten Port, Up to 10 devices and one MATE	1
FW-X240	Autotransformer 4 kVA 120/240VAC 60Hz	1
FW-Cable175-36R	175 Amp 2/0 AWG DC cable 36 inches (915 mm) long with ring terminals on both ends with red heat shrink	2
FW-Cable175-36W	175 Amp 2/0 AWG DC cable 36 inches (915 mm) long with ring terminals on both ends with white heat shrink	2

Sample Bill of Materials

FW1000 With FW-IOB-Q-120/240VAC - Example of system with four VFX3648 Outback Power Inverter/Chargers in Series/Parallel

Part #	Description	Qty
VFX3648 Inverter/Charger	3600 W, 48 VDC, 45 amp charger, 60 amp AC input	4
FW-ACA	AC Conduit Adapter for all FX Series Inverter/Chargers to AC enclosure.	4
DCA	DC Conduit Adapter for all FX Series Inverter/Chargers to DC enclosure.	4
FW1000-DC	DC breaker enclosure – fits at the DC side of up to four FX Series Inverter/Chargers	1
OBB-175-125VDC-PNL	175 amp, 125VDC breaker with 3/8" stud terminals	4
FW1000-AC	AC breaker enclosure – fits at the AC side of up to four FX Series Inverter/Chargers	1
FW-IOB-Q-120/240VAC	Quad inverter Input-Output-Bypass for FW1000	1
FW-MP	Mounting Plate for FW500 or FW1000 system	2
MATE	System Display and Controller	1
HUB-10	Ten Port, Up to 10 devices and one MATE	1
FW-X240	Autotransformer 4 kVA 120/240VAC 60Hz with 25 Amp \$390	1
FW-Cable175-36R	175 Amp 2/0 AWG DC cable 36 inches (915 mm) long with ring terminals on both ends with red heat shrink	4
FW-Cable175-36W	175 Amp 2/0 AWG DC cable 36 inches (915 mm) long with ring terminals on both ends with white heat shrink	4

FW1000 With FW-IOB-T-120/208VAC - Example of 3-phase system with three VFX3648 Outback Power Inverter/Chargers

Part #	Description	Qty
VFX3648 Inverter/Charger	3600 W, 48 VDC, 45 amp charger, 60 amp AC input	3
FW-ACA	AC Conduit Adapter for all FX Series Inverter/Chargers to AC enclosure.	3
DCA	DC Conduit Adapter for all FX Series Inverter/Chargers to DC enclosure.	3
FW1000-DC	DC breaker enclosure – fits at the DC side of up to four FX Series Inverter/Chargers	1
OBB-175-125VDC-PNL	175 amp, 125VDC breaker with 3/8" stud terminals	3
FW1000-AC	AC breaker enclosure – fits at the AC side of up to four FX Series Inverter/Chargers	1
FW-IOB-T-120/208VAC	Triple inverter Input-Output-Bypass for FW1000	1
FW-MP	Mounting Plate for FW500 or FW1000 system	2
MATE	System Display and Controller	1
HUB-10	Ten Port, Up to 10 devices and one MATE	1
FW-Cable175-36R	175 Amp 2/0 AWG DC cable 36 inches (915 mm) long with ring terminals on both ends with red heat shrink	3
FW-Cable175-36W	175 Amp 2/0 AWG DC cable 36 inches (915 mm) long with ring terminals on both ends with white heat shrink	3

FW1000 With FW-IOB-T-230/400VAC - Example of 3-phase system with three VFX3024E OutBack Power Inverter/Chargers

Part#	Description	Qty
VFX3024E	3000W, 24VDC, 85 amps DC charger, 30 amps AC input	3
FW-ACA	AC Conduit adapter for all FX Series Inverter/Chargers to AC enclosure	3
DCA	DC Conduit adapter for all FX Series Inverter/Chargers to DC enclosure	3
FW1000-DC	DC breaker enclosure - fits at the DC side of up to four FX Series Inverter/Chargers	1
OBB-250-125VDC-PNL	DC Breaker 250 amps	3
FW1000-AC	AC breaker enclosure - fits at the AC side of up to four FX Series Inverter/Chargers	1
FW-IOB-T-230/400VAC	Triple inverter Input-Output-Bypass for FW500	1
FW-MP	Mounting Plate for FW500 or FW1000 System	2
MATE	System display and Controller	1
HUB10	Ten Port, up to 10 devices and one MATE	1

The FLEXware MP is a one-piece, powder-coated aluminum mounting plate for FLEXware 500 and FLEXware 1000 enclosures. Utilizing stainless steel mounting hardware, the integrated locating bolts make installation quick and easy by providing guides to line up enclosures and inverter/chargers. A single FLEXware MP is designed to accommodate a FLEXware 500 while two FLEXware MPs are utilized in a FLEXware 1000 configuration.

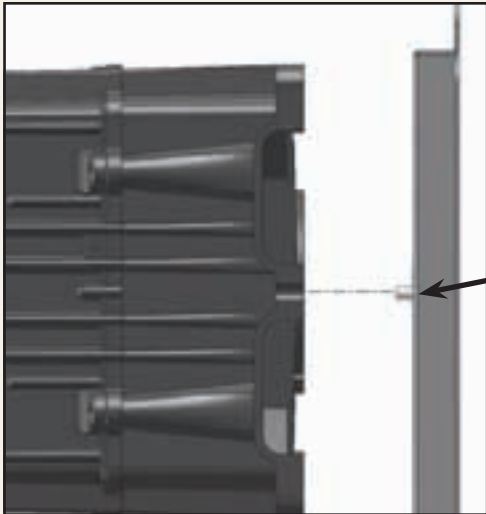

Side View of Integrated Locating Bolts

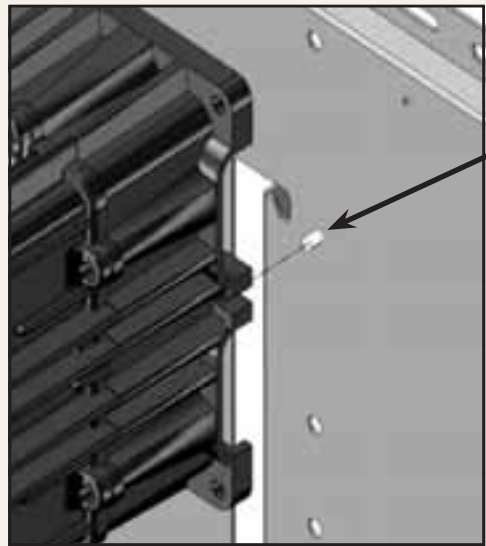

Angled View of Integrated Locating Bolts

Single MP Configuration for FLEXware 500

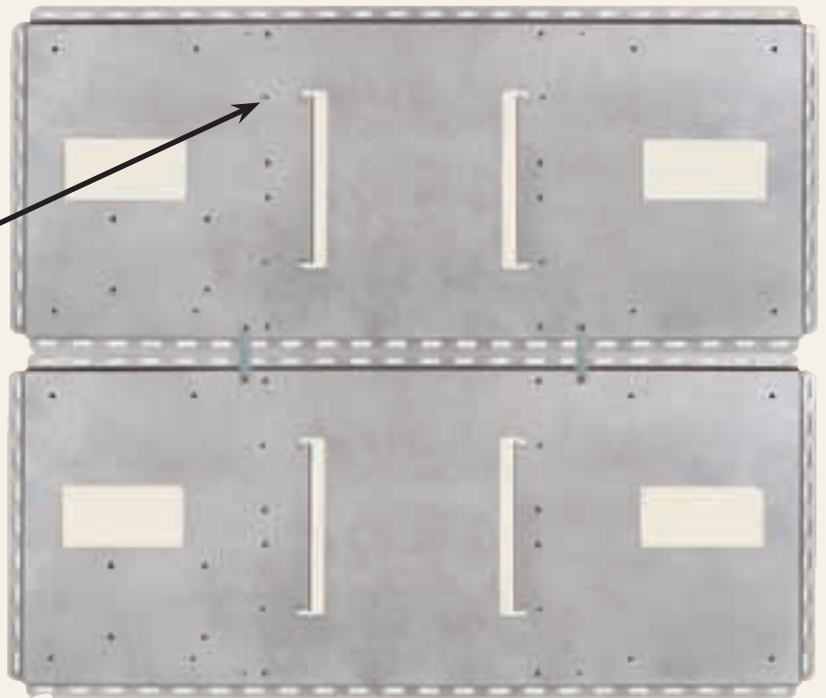
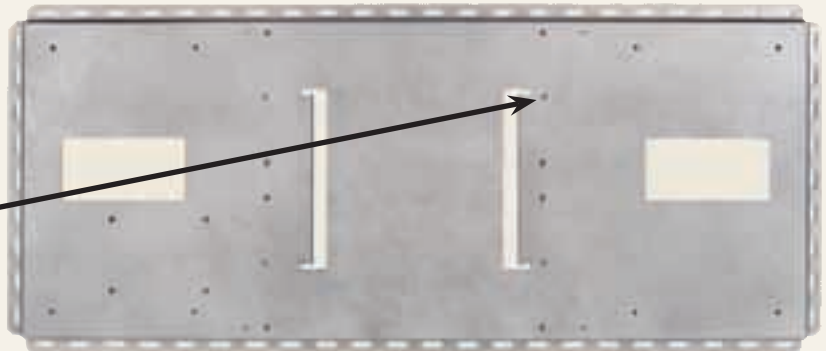

Model: FW-MP

Description: FLEXware system mounting plate

Unit Dimensions (H x W x D)

20.3 x 46.3 x .8" (51.6 x 117.6 x 2.1 cm)

Shipping Dimensions (H x W x L)

1.15 x 22.9 x 48.4" (2.9 x 58.2 x 123 cm)

Shipping Weight

14 lbs. (6.4 kg)

Components

OutBack DIN Mount Breakers

DIN rail mountable, hydraulic-magnetic type breakers that can be used for input, output or load circuits.



Model	Current Rating	Voltage Rating	Branch Circuit	Variation	Width
OBB-15-120VAC-DIN	15 amp	120VAC 50/60Hz	10k AIC	Single pole	0.50" (13 mm)
OBB-15D-240VAC-DIN	15 amp	120/240VAC 50/60Hz	10k AIC	Dual pole	1.0" (26 mm)
OBB-20-120VAC-DIN	20 amp	120VAC 50/60Hz	10k AIC	Single pole	0.50" (13 mm)
OBB-20D-240VAC-DIN	20 amp	120/240VAC 50/60Hz	10k AIC	Dual pole	1.0" (26 mm)
OBB-25D-240VAC-DIN	25 amp	120/240VAC 50/60Hz	10k AIC	Dual pole	1.0" (26 mm)
OBB-10-277VAC-DIN	10 amp	277VAC 50/60Hz	N/A	Single pole	0.5" (13 mm)
OBB-15-277VAC-DIN	15 amp	277VAC 50/60Hz	N/A	Single pole	0.5" (13 mm)
OBB-30-277VAC-DIN	30 amp	277VAC 50/60Hz	N/A	Single pole	0.5" (13 mm)
OBB-30D-480VAC-DIN	30 amp	277/480VAC 50/60Hz	N/A	Dual pole	1.0" (26 mm)
OBB-30T-480VAC-DIN	30 amp	277/480VAC 50/60Hz	N/A	Three pole	1.5" (39 mm)
OBB-50-277VAC-DIN	50 amp	277VAC 50/60Hz	N/A	Single pole	0.5" (13 mm)
OBB-50D-480VAC-DIN	50 amp	277/480VAC 50/60Hz	N/A	Dual pole	1.0" (26 mm)
OBB-50T-480VAC-DIN	50 amp	277/480VAC 50/60Hz	N/A	Three pole	1.5" (39 mm)
OBB-60-277VAC-DIN	60 amp	277VAC 50/60Hz	N/A	Single pole	0.5" (13 mm)

- #14 to 2 AWG clamp terminals

OutBack Panel Mount Breakers

Panel mounted hydraulic-magnetic type breakers that can be used for DC sources, inverters or load circuits.



Model	Current Rating	Voltage Rating	Branch Circuit	Terminals	Width
OBB-1-150VDC120VAC-PNL	1 amp	150VDC 120VAC	10k AIC	1/4" stud	0.75" (19 mm)
OBB-5-150VDC120VAC-PNL	5 amp	150VDC 120VAC	10k AIC	1/4" stud	0.75" (19 mm)
OBB-10-150VDC120VAC-PNL	10 amp	150VDC 120VAC	10k AIC	1/4" stud	0.75" (19 mm)
OBB-15-150VDC120VAC-PNL	15 amp	150VDC 120VAC	10k AIC	1/4" stud	0.75" (19 mm)
OBB-20-150VDC120VAC-PNL	20 amp	150VDC 120VAC	10k AIC	1/4" stud	0.75" (19 mm)
OBB-30-150VDC120VAC-PNL	30 amp	150VDC 120VAC	10k AIC	1/4" stud	0.75" (19 mm)
OBB-30-250VAC-PNL	30 amp	250VAC	NA	1/4" stud	0.75" (19 mm)
OBB-40-150VDC120VAC-PNL	40 amp	150VDC 120VAC	10k AIC	1/4" stud	0.75" (19 mm)
OBB-50-150VDC120VAC-PNL	50 amp	150VDC 120VAC	10k AIC	1/4" stud	0.75" (19 mm)
OBB-60-150VDC120VAC-PNL	60 amp	150VDC 120VAC	10k AIC	1/4" stud	0.75" (19 mm)
OBB-80-150VDC-PNL	80 amp	150VDC	N/A	1/4" stud	0.75" (19 mm)
OBB-100-125VDC-PNL	100 amp	125VDC	N/A	5/16" stud	1.0" (26 mm)
OBB-125-125VDC-PNL	125 amp	125VDC	N/A	5/16" stud	1.0" (26 mm)
OBB-175-125VDC-PNL	175 amp	125VDC	N/A	3/8" stud	1.5" (39 mm)
OBB-250-125VDC-PNL	250 amp	125VDC	N/A	3/8" stud	1.5" (39 mm)

- ETL Listed for 150 VDC max open circuit. For PV applications.

Components

OutBack PV Ground-Fault Detection and Interruption System

Ground fault detection and interruption is required by US National Electric Code for PV arrays mounted on or within a specified vicinity of residential dwelling roofs as a safety precaution. The OutBack PV Ground-Fault Detection and Interruption System protects wiring and system components for one, two or four PV arrays when used in a FLEXware 250, FLEXware 500 or FLEXware 1000.



Model	Description	Terminals	Width
OBB-GFDI-80-150VDC-PNL	PV Ground-Fault Detector Interrupter 80 amp 150VDC single pole panel mount	1/4" stud	1.515" (38.5 mm)
OBB-GFDI-80D-150VDC-PNL	PV Ground-Fault Detector Interrupter 80 amp 150VDC two pole panel mount	1/4" stud	2.265" (57.3 mm)
OBB-GFDI-80Q-150VDC-PNL	PV Ground-Fault Detector Interrupter 80 amp 150VDC four pole panel mount	1/4" stud	2.775" (95.9mm)

Uses two, three or four 3/4" wide panel mount breaker spaces

FW-X240 Auto-transformer

Designed to be housed within the FLEXware 500 or FLEXware 1000 AC enclosures. The FW-X240 Auto-transformer with a 120 volt/30 amp primary and secondary winding can be used for step-up, step-down, generator and split-phase output balancing for series stacked inverters. It can transfer 2kW from one 120 VAC leg of a generator or the total rating of an OutBack stacked series/parallel 120/240 VAC inverter/charger configuration.

Model	Description	Includes
FW-X240	Auto-transformer 4 kVA 120/240VAC 60Hz with 25 amp dual pole breaker for mounting inside of FLEXware 500-AC or FLEXware 1000-AC	Auto-transformer , 25 amp dual pole breaker and mounting hardware

DC Bus Bars

OutBack DC bus bars are designed to enable the most complex of code compliant DC cable connections.



Model	Description	Includes
FW-BBUS	Breaker Bus allows connection of two 175-250 amp, three 100-125 amp, four 1-80 amp DC breakers or three 500 amp DC current shunts	Plated copper plate rated for 500 amps and two 5/16 inch bolts for mounting
FW-CBUS-8	Combiner Bus connects up to eight DIN mounted breakers or six DIN mounted fuse holders	Two 2/0 AWG box lug terminals - plated copper plate rated for 200 amps
FW-CBUS-12	Combiner Bus connects up to twelve DIN mounted breakers or eight DIN mounted fuse holders	Two 2/0 AWG box lug terminals - plated copper plate rated for 200 amps
FW-SBUS	Shunt Bus allows up to four high current cable connections on same side of DC shunt	Two 3/8 inch bolts solid brass rated for 1000 amps

DC Current Shunts

When used with an amp hour meter, OutBack Power Technologies DC current shunt kits can provide valuable insight into the status of your batteries or DC power source. One shunt kit is included standard on FLEXware 500 and FLEXware 1000 DC enclosures.



Model	Description	Includes
FW-SHUNT250	500 amp DC current shunt with terminal bus bar for mounting on top of a FX Series Inverter/Charger	Shunt, mounting hardware and terminal bus bar for connection to FX Inverter's DC negative terminal
FW-SHUNT500	500 amp DC current shunt with terminal bus bar	Shunt, terminal bus bar and one white insulator and mounting screws

Components

Conduit Adapters

Allows connection of the FX and VFX Series Inverter/Chargers to FLEXware 500 and FLEXware 1000 enclosures, one FW-ACA and DCA required per FX Series Inverter/Charger.

Model	Description	Includes
FW-ACA	Adapter for AC end of FX Series Inverter/Charger	FW-ACA and mounting hardware
DCA	Adapter for DC end of FX Series Inverter/Charger	DCA, bushing and mounting hardware

Mounting Brackets

FW-CCB and FW-CCB2 mounting brackets allow OutBack Power Technologies charge controllers to be mounted on the side of FW500-DC or FW1000-DC enclosures.

FW-CCB2-T mounting bracket allows OutBack Power Technologies charge controllers to be mounted on the top of FW500-DC or FW1000-DC enclosures.

FW-MB1 mounting bracket allows OutBack Power system displays to be mounted on the side of FW500-AC and FW1000-AC enclosures.

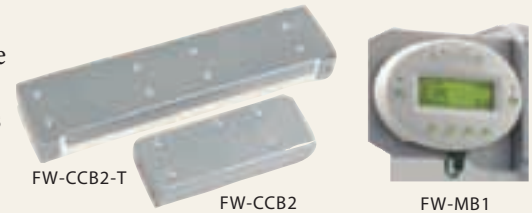

Model	Description	Includes
FW-CCB	Bracket for mounting a single FLEXmax Series Charge Controller	Bracket, bushings and mounting hardware
FW-CCB2	Bracket for mounting two FLEXmax Series Charge Controllers	Brackets, bushings and mounting hardware
FW-CCB2-T	Bracket for top mounting two FLEXmax Series Charge Controllers	Bracket, bushings and mounting hardware
FW-MB1	Bracket for mounting a MATE System Display	Bracket, bushings and mounting hardware
FW-MB2	Bracket for mounting a MATE2 System Display	Bracket, bushings and mounting hardware

DIN Rail End Clamp

Model	Description	Width
FW-EC-DIN	DIN rail mountable securing device for DIN rail mountable fuses or breakers.	.4" (10 mm)

DC Cable Assemblies

DC interconnect cable assemblies for wiring between inverter/chargers and breakers or DC shunts. Can also be used as battery interconnects. The THW type cable assemblies are UL listed and NEC compliant with a maximum voltage rating of 1000VDC and a temperature rating of 105°C.

Model	Description	Hole to hole length
FW-CABLE250-15R	250 amp 4/0 AWG (11.7 mm) DC cable 15 inches (380 mm) long with ring terminals on both ends and red heat shrink. For connection from 250 amp DC breaker to inverter positive terminal.	19" (483 mm)
FW-CABLE175-15R	175 amp 2/0 AWG (9.26 mm) DC cable 15 inches (380 mm) long with ring terminals on both ends and red heat shrink. For connection from 175 amp DC breaker to inverter positive terminal.	19" (483 mm)
FW-CABLE250-36R	250 amp 4/0 AWG (11.7 mm) DC cable 36 inches (915 mm) long with ring terminals on both ends and red heat shrink. For connection from 250 amp DC breaker to inverter positive terminal.	40" (1016 mm)
FW-CABLE175-36R	175 amp 2/0 AWG (9.26 mm) DC cable 36 inches (915 mm) long with ring terminals on both ends and red heat shrink. For connection from 175 amp DC breaker to inverter positive terminal.	40" (1016 mm)
FW-CABLE250-36W	250 amp 4/0 AWG (11.7 mm) DC cable 36 inches (915 mm) long with ring terminals on both ends and white heat shrink. For connection from DC current shunt to inverter negative terminal.	40" (1016 mm)
FW-CABLE175-36W	175 amp 2/0 AWG (9.26 mm) DC cable 36 inches (915 mm) long with ring terminals on both ends and white heat shrink. For connection from DC current shunt to inverter negative terminal.	40" (1016 mm)

- All ring lugs have 3/8" (9.53 mm) diameter hole.

The OutBack Power Technologies FLEXware PV combiner series sets the new standard for PV balance-of-system hardware. Ideal for both small or large systems, the FLEXware PV8 and FLEXware PV12 accommodates the overcurrent protection requirements of your application. From 150VDC breakers for low voltage PV systems, to 600VDC fuse holders for high voltage PV systems, the FLEXware PV Combiner series handles it all.

Designed to survive in outdoor environments, the rainproof, type 3R powder coated aluminum chassis can be mounted on a wall, sloped roof or pole. The unique angled negative terminal bus bar design makes wiring fast and easy without the larger output conductors blocking access to the smaller input terminals. Dual output lug terminals are included for up to 2/0 AWG conductors. The tinted flame-retardant polycarbonate deadfront panel creates a clean appearance while preventing accidental contact with the live terminals and is easily removable during installation.

The FLEXware PV Combiner makes it easy to take your installation to the next level.

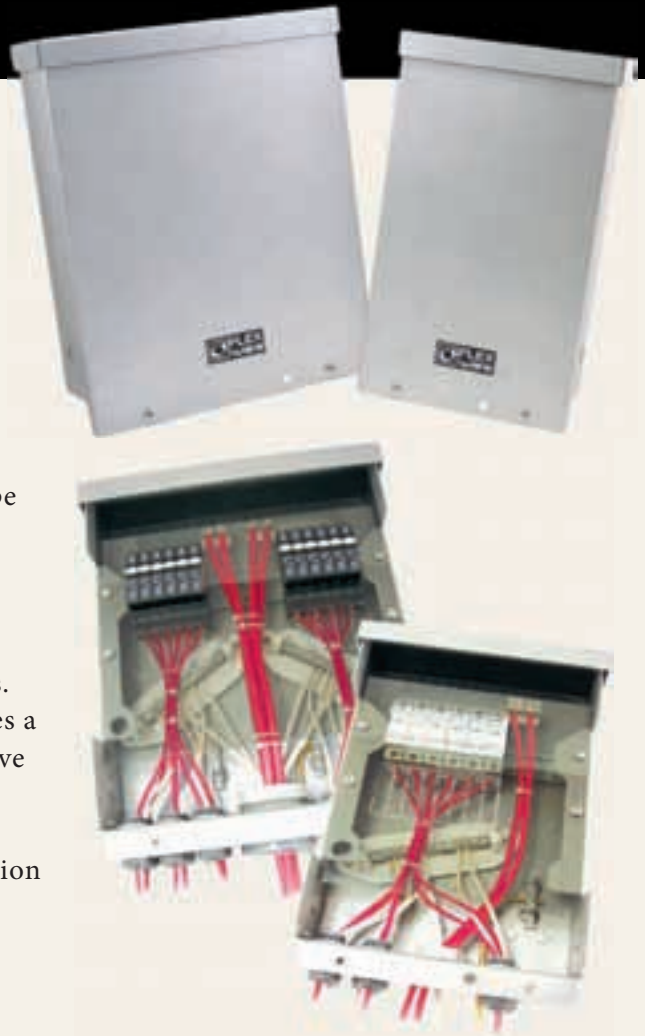

FLEXware™ PV Specifications

		FWPV-8	FWPV-12
Enclosure Material		Powder coated aluminum with stainless steel hardware	Powder coated aluminum with stainless steel hardware
Mounting Options		Vertical wall mount, pole mount or sloped roof mount to 14 degrees incline (3 in 12 roof pitch)	Vertical wall mount, pole mount or sloped roof mount to 14 degrees incline (3 in 12 roof pitch)
Enclosure Rating		Outdoor Rainproof, UL Type 3R	Outdoor Rainproof, UL Type 3R
Enclosure Security		Padlock hole in chassis and cover for up to 3/8 inch pad lock	Padlock hole in chassis and cover for up to 3/8 inch pad lock
Output Terminals		#14 - 2/0 AWG (2.08 - 67.43 mm ²) Two box lug terminals included	#14 - 2/0 AWG (2.08 - 67.43 mm ²) Four box lug terminals included
Number of separate circuits		One Circuit	One or Two Circuits
Number of 150VDC breakers		up to 8	up to 12 (two groups of six)
Number of 600VDC fuse holders		up to 6	up to 8 (two groups of four)
Input Terminal		150VDC Breakers / #14 - 6 AWG (2.08 - 13.3 mm ²) 600VDC Fuse / #14 - 10 AWG (2.08 - 5.26 mm ²)	150VDC Breakers / #14 - 6 AWG (2.08 - 13.3 mm ²) 600VDC Fuse / #14 - 10 AWG (2.08 - 5.26 mm ²)
Dimensions	Unit (H x W x D)	15.2 x 9.2 x 3.9" (38.7 x 23.3 x 9.9 cm)	15.2 x 12.7 x 3.9" (38.7 x 32.2 x 9.9 cm)
	Shipping (H x W x L)	4.3 x 9.5 x 19" (10.9 x 24.1 x 48.3 cm)	4.3 x 13 x 19" (10.9 x 33 x 48.3 cm)
Weight	Unit	4.4 lbs (2.0 kg)	5.9 lbs (2.7 kg)
	Shipping	5.5 lbs (2.5 kg)	7.4 lbs (3.3 kg)

* Specifications subject to change without notice. Use appropriate wire size in accordance with NEC.

OutBack DC DIN Mount Breakers

DIN rail mount breakers are hydraulic-magnetic type and are not affected by high ambient temperatures.

Model	Current Rating	Voltage Rating*	Terminals	Width
OBB-1-125VDC-DIN	1 amp	125VDC	#14 to 2 AWG clamp terminals	0.5" (13 mm)
OBB-2-150VDC-DIN	2 amp	150VDC	#14 to 2 AWG clamp terminals	0.5" (13 mm)
OBB-3-150VDC-DIN	3 amp	150VDC	#14 to 2 AWG clamp terminals	0.5" (13 mm)
OBB-4-150VDC-DIN	4 amp	150VDC	#14 to 2 AWG clamp terminals	0.5" (13 mm)
OBB-5-150VDC-DIN	5 amp	150VDC	#14 to 2 AWG clamp terminals	0.5" (13 mm)
OBB-6-150VDC-DIN	6 amp	150VDC	#14 to 2 AWG clamp terminals	0.5" (13 mm)
OBB-8-150VDC-DIN	8 amp	150VDC	#14 to 2 AWG clamp terminals	0.5" (13 mm)
OBB-9-150VDC-DIN	9 amp	150VDC	#14 to 2 AWG clamp terminals	0.5" (13 mm)
OBB-10-150VDC-DIN	10 amp	150VDC	#14 to 2 AWG clamp terminals	0.5" (13 mm)
OBB-15-150VDC-DIN	15 amp	150VDC	#14 to 2 AWG clamp terminals	0.5" (13 mm)
OBB-20-125VDC-DIN	20 amp	125VDC	#14 to 2 AWG clamp terminals	0.5" (13 mm)
OBB-30-125VDC-DIN	30 amp	125VDC	#14 to 2 AWG clamp terminals	0.5" (13 mm)
OBB-50-125VDC-DIN	50 amp	125VDC	#14 to 2 AWG clamp terminals	0.5" (13 mm)
OBB-60-125VDC-DIN	60 amp	125VDC	#14 to 2 AWG clamp terminals	0.5" (13 mm)

* Approved for maximum VOC of 150 VDC by ETL for PV array applications only.

OutBack High Voltage DIN Mount Fuse Holders and Fuses

Fuse holders are DIN rail mount with #8 AWG set-screw type compression terminals. Touch-safe design and not rated for load make or load break usage.

Model	Description	Current Rating	Voltage Rating	Width
OBF-6-600VDC	Fuse	6 amp	600VDC	N/A
OBF-10-600VDC	Fuse	10 amp	600VDC	N/A
OBF-15-600VDC	Fuse	15 amp	600VDC	N/A
OBFH-30-600VDC-DIN	Fuse Holder	30 amp	600VDC	0.7" (18 mm)

Terminal Bus Bars

Used for adding more wire terminations or for isolating multiple positive/negative circuits. All TBB models have three #1/0 to 14 AWG and eight #6 to 14 AWG screw type compression terminals, which means no ring lugs are required. Available with black, white, red, blue and brown insulators. All required TBBs are included with the AC Input-Output-Bypass Assemblies. TBBs rated for a maximum of 180 amps AC/DC.



Model	Description	Terminals
TBB-GROUND	Ground/Neutral terminal bus bar and mounting screws (no insulators)	Three #1/0 to 14 AWG and Eight #6 to 14 AWG screw type compression
TBB-BLACK	Bus bar with black insulators and mounting screws	Three #1/0 to 14 AWG and Eight #6 to 14 AWG screw type compression terminals
TBB-BLUE	Bus bar with blue insulators and mounting screws	Three #1/0 to 14 AWG and Eight #6 to 14 AWG screw type compression terminals
TBB-RED	Bus bar with red insulators and mounting screws	Three #1/0 to 14 AWG and Eight #6 to 14 AWG screw type compression terminals
TBB-WHITE	Bus bar with white insulators and mounting screws	Three #1/0 to 14 AWG and Eight #6 to 14 AWG screw type compression terminals
TBB-BROWN	Bus bar with brown insulators and mounting screws	Three #1/0 to 14 AWG and Eight #6 to 14 AWG screw type compression terminals



Corporate Headquarters
19009 62nd Avenue NE
Arlington, WA 98223 USA
Phone: 360.435.6030
Fax: 360.435.6019

European Office
Phone: +34.93.654.9568

www.outbackpower.com



www.coltecnica.com
(571) 4737687
colsolar@coltecnica.com
Bogotá - Colombia